

INSTRUCCIONES ARMADO

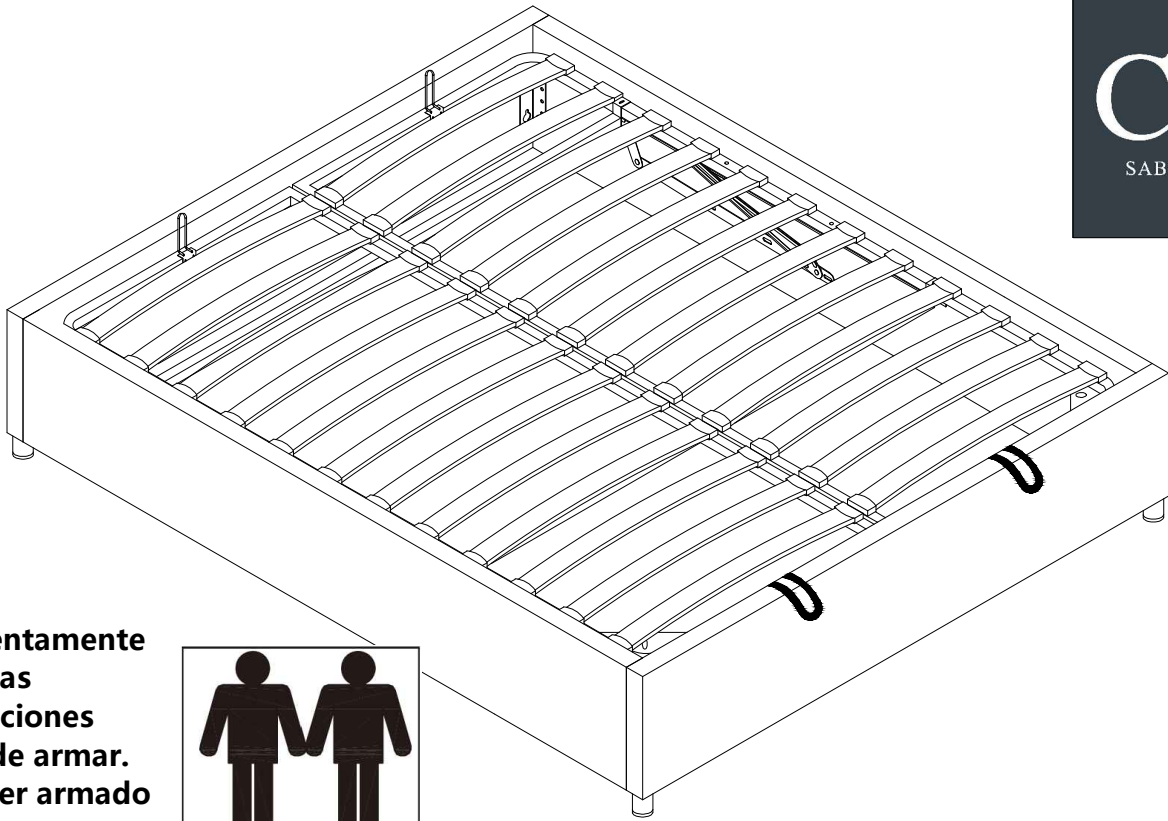

Lea atentamente todas las instrucciones antes de armar. Debe ser armado por dos personas.

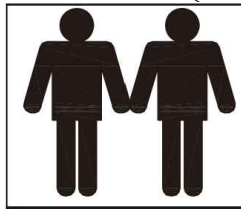

- | | | | | | | | |
|------------------------|-----------------------|----------------------|----------------------|------------------------|-----------------------|--------------------|-----------------------|
|
163*33cm
A.1PC |
163*33cm
B.1PC |
202.5cm
C.1PC |
202.5cm
D.1PC |
200*152cm
E.1PC | | | |
|
200*76cm
F.2PCS |
106cm
G.1PC |
106cm
H.1PC |
48cm
I.2PCS |
22cm
J.2PCS |
152cm
K.2PCS | | |
|
Ø6*5cm
L.4PCS |
12*5cm
M.1PC |
15*4cm
N.4PCS |
18*6cm
O.2PCS |
8*1.5cm
P.48PCS |
76*8cm
Q.24PCS |
R.2PCS |
Ø6*5cm
S.12PCS |
|
M8*45
T.14PCS |
M8*25
V.32PCS |
40MM
W.12PCS |
M8
X.12PCS |
M8
Y.1PC |
M8
Z.1PC |
M8
II.46PCS | |

INSTRUCCIONES ARMADO

Paso:1

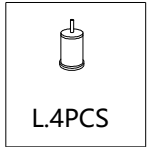
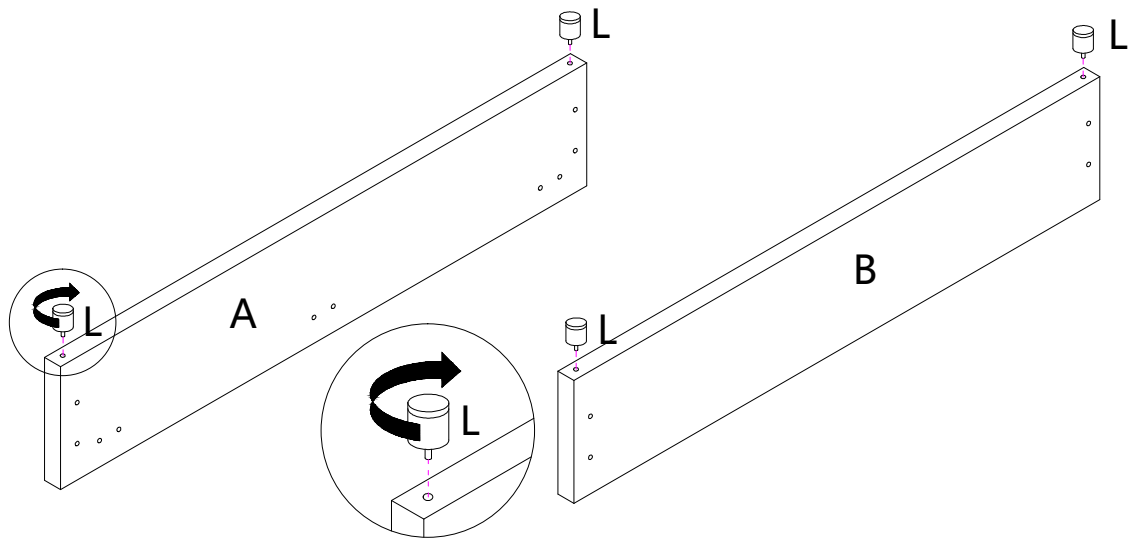



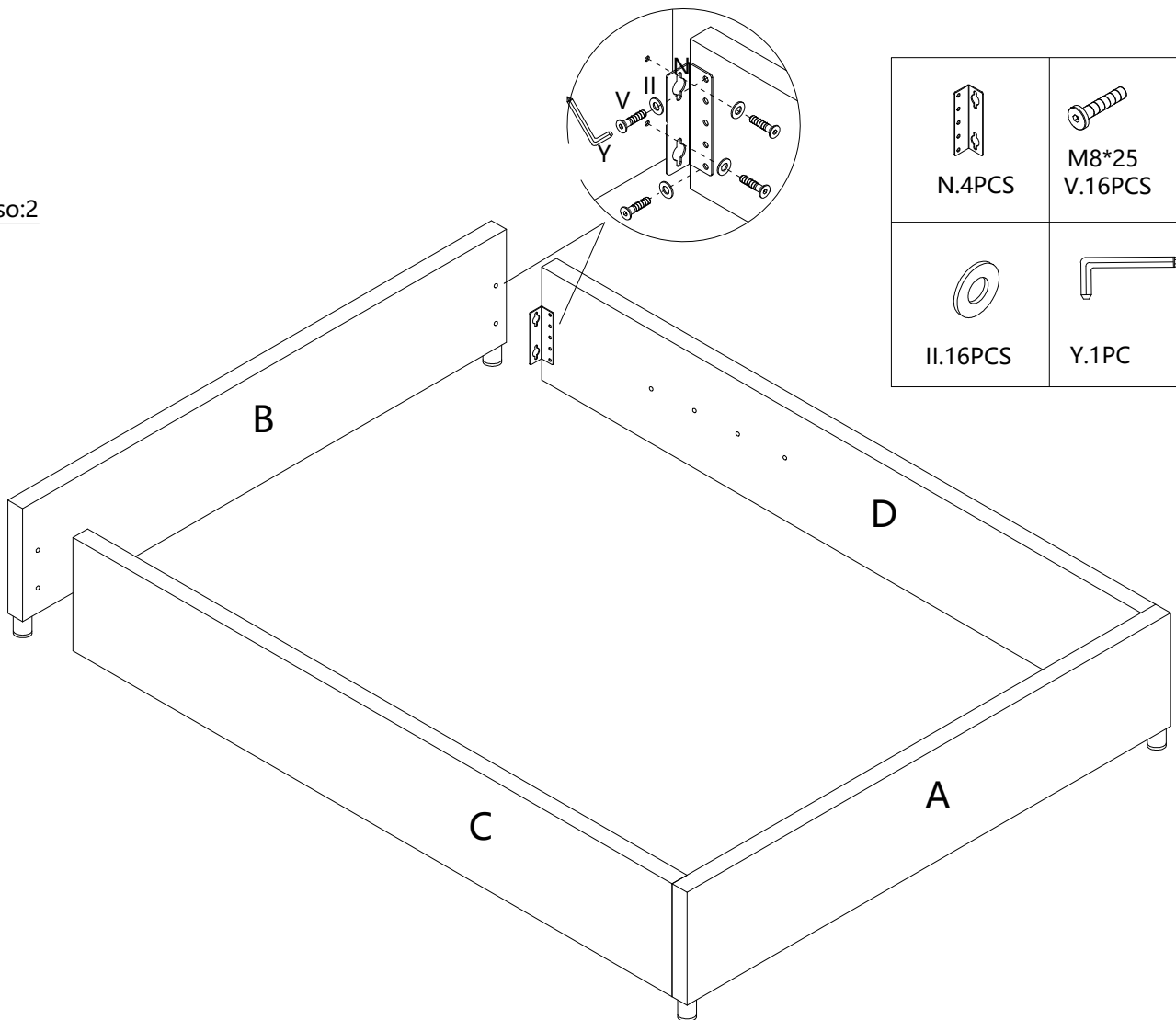



Paso:2

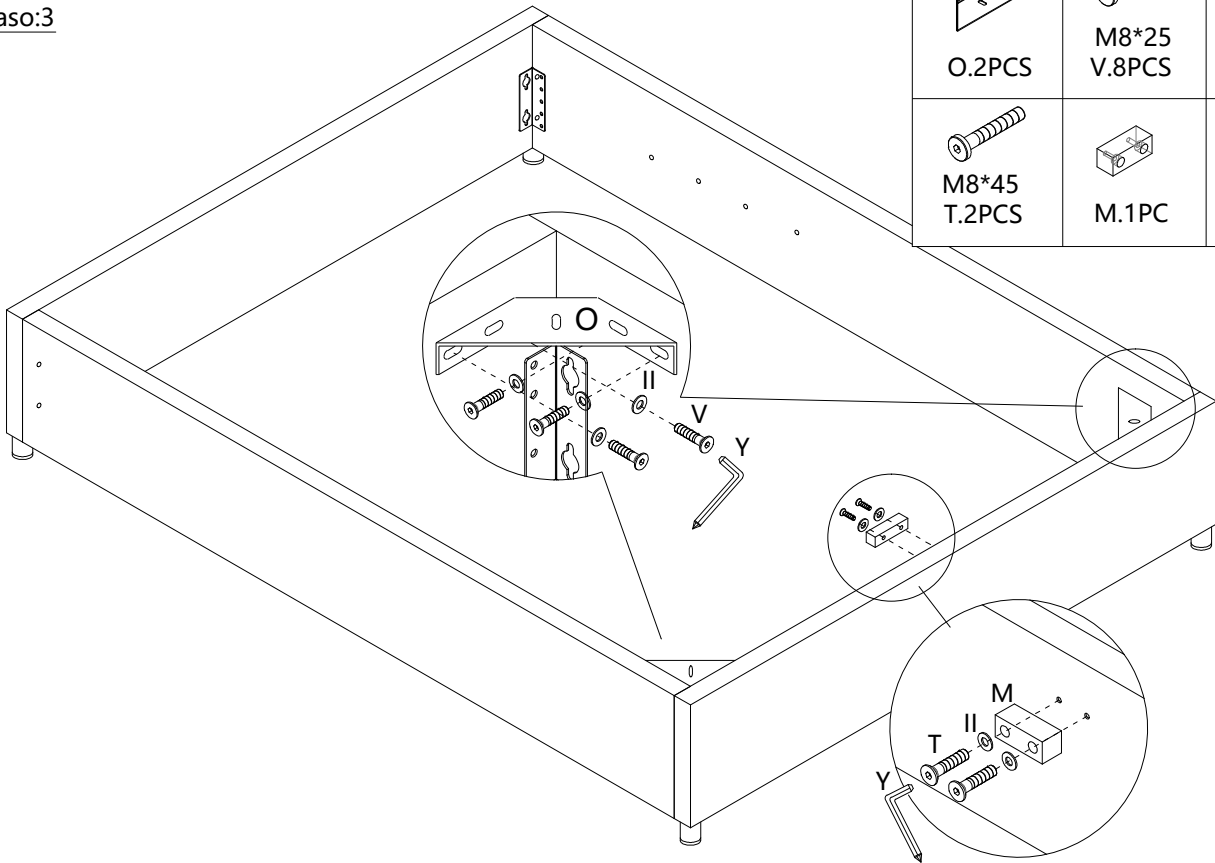

INSTRUCCIONES ARMADO



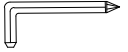

Paso:3

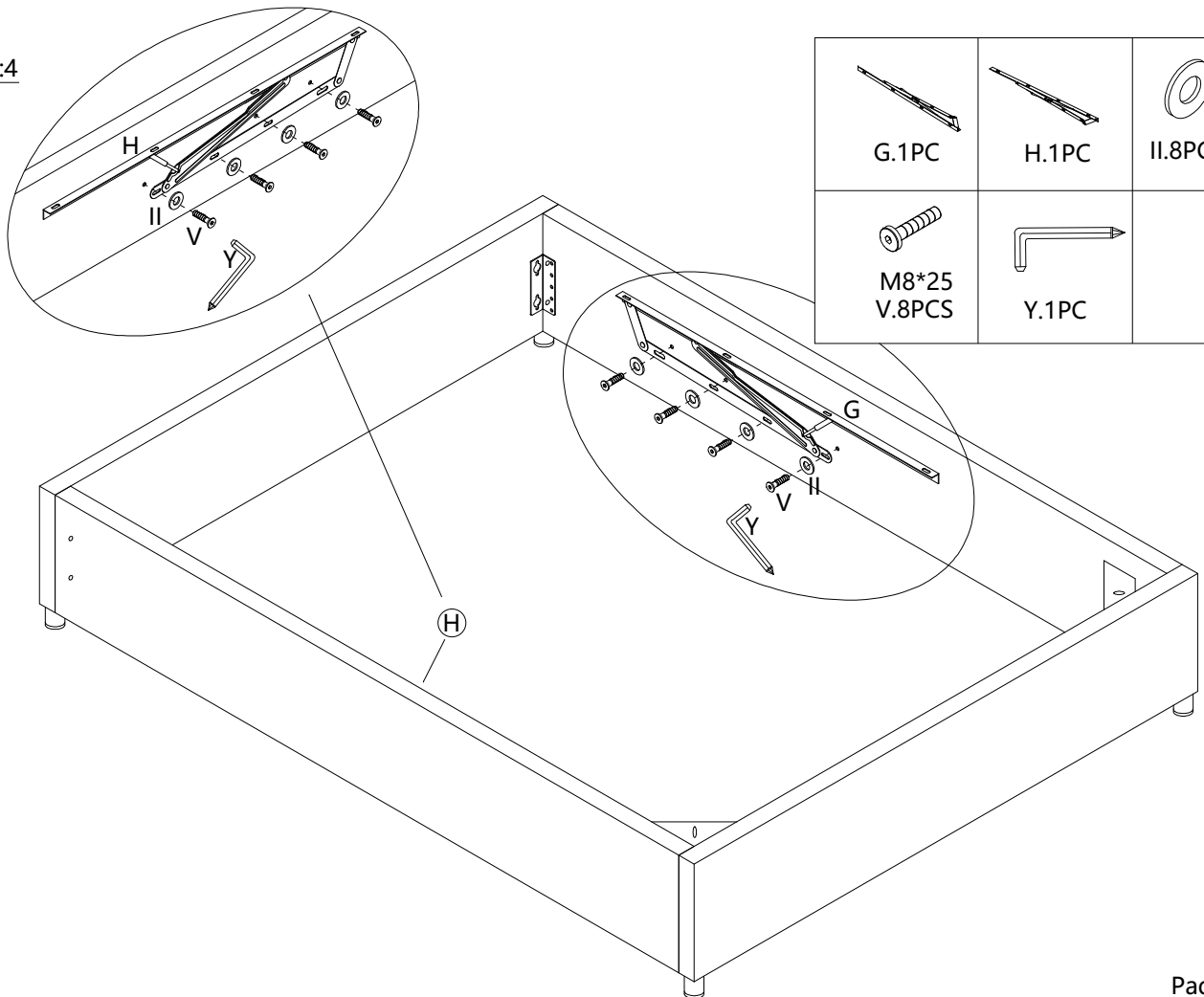

 O.2PCS	 M8*25 V.8PCS	 II.10PCS
 M8*45 T.2PCS	 M.1PC	 Y.1PC

Paso:4



 G.1PC	 H.1PC	 II.8PCS
 M8*25 V.8PCS	 Y.1PC	

INSTRUCCIONES ARMADO

Paso:5

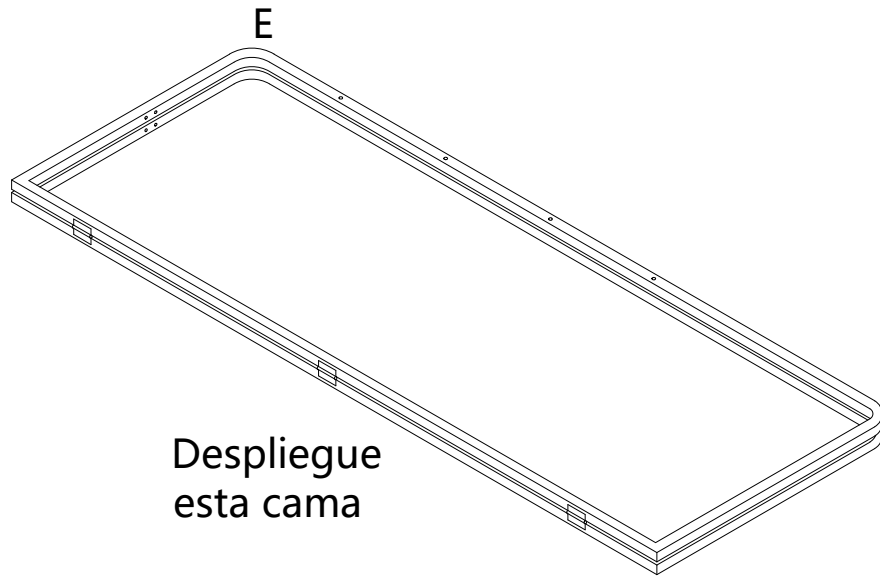



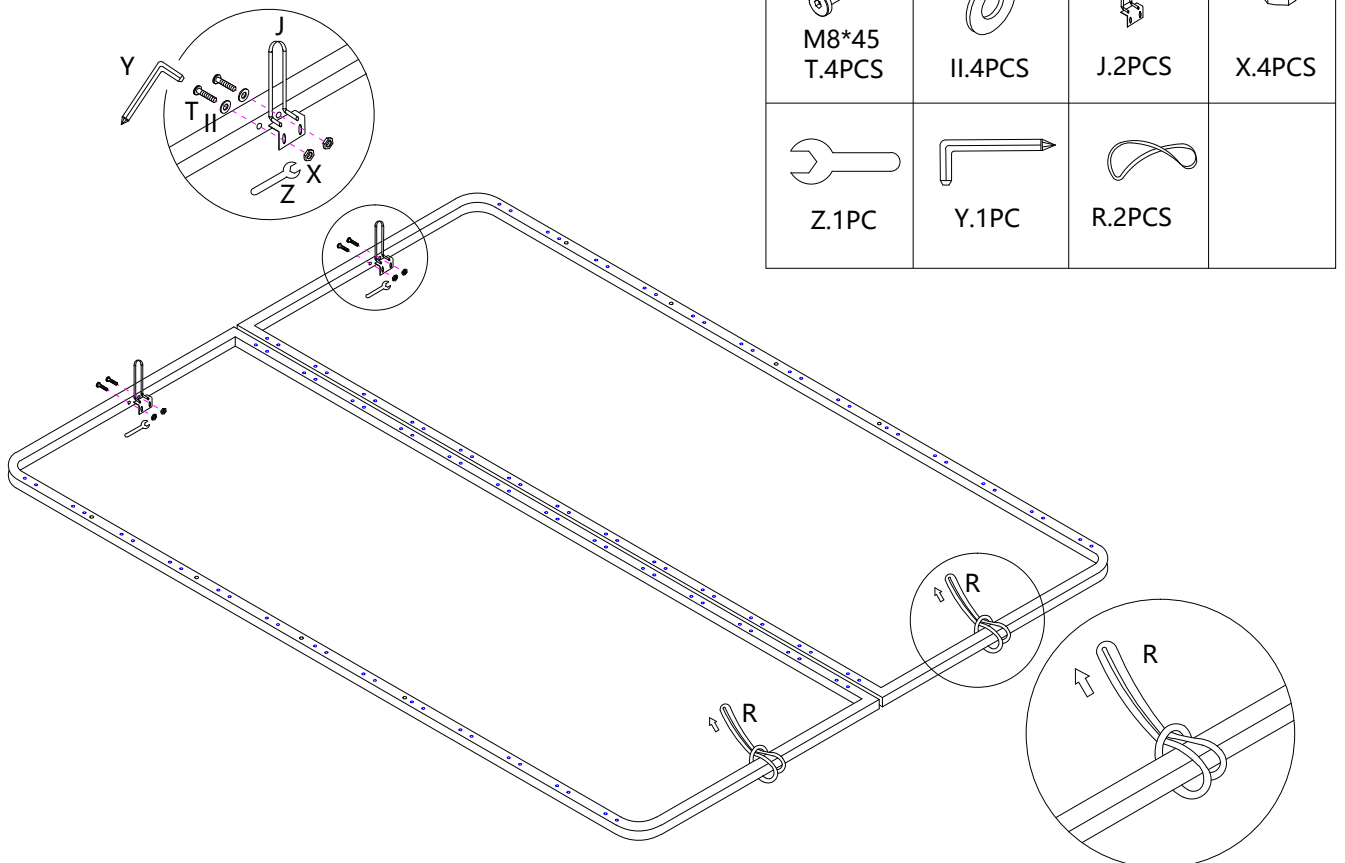

Paso:6



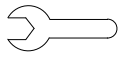

INSTRUCCIONES ARMADO

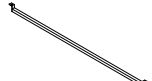
Paso:7

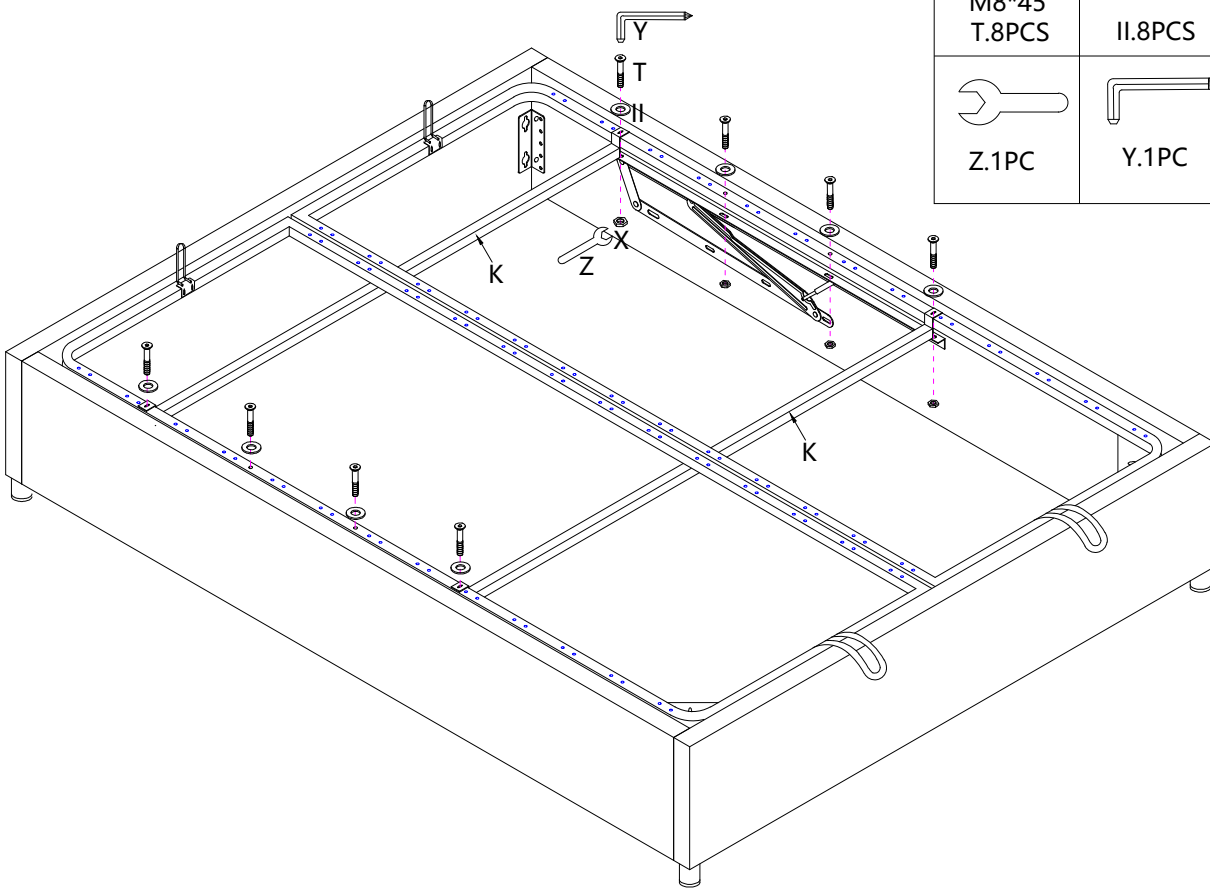
 M8*45 T.8PCS	 II.8PCS	 X.8PCS
 Z.1PC	 Y.1PC	 K.2PCS



Paso:8

 P.48PCS	 Q.24PCS
--	--

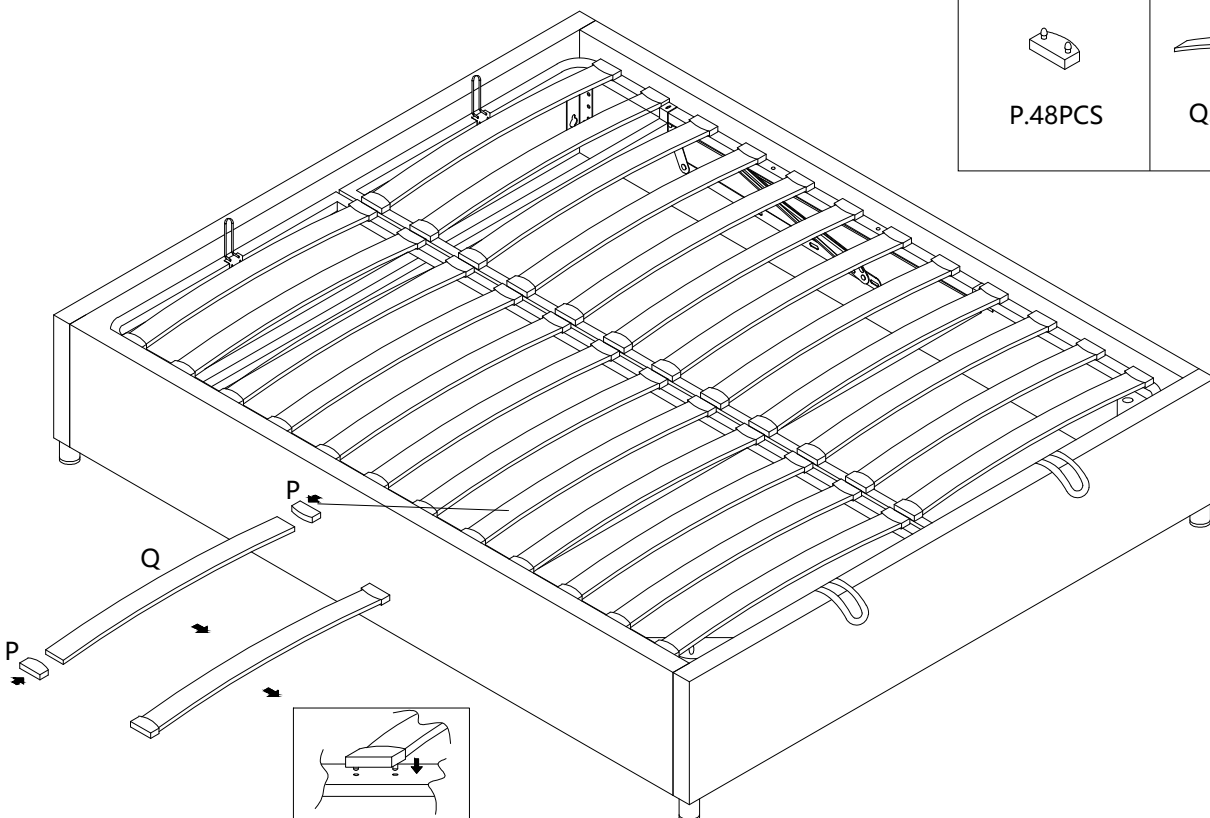

INSTRUCCIONES ARMADO

Paso:9

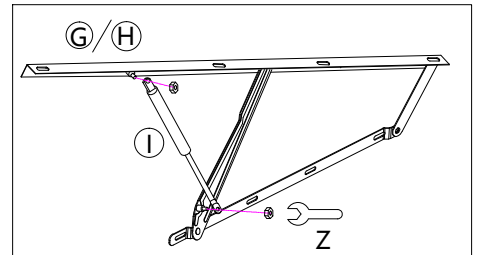
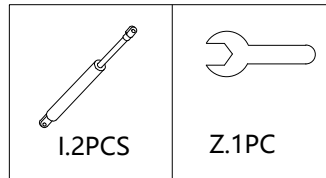

El pistón cilíndrico del marco articulado no está completamente instalado. Atornille las tuercas en ambos extremos como se muestra en la figura, instale el marco articulado del pistón cilíndrico asegúrelo.

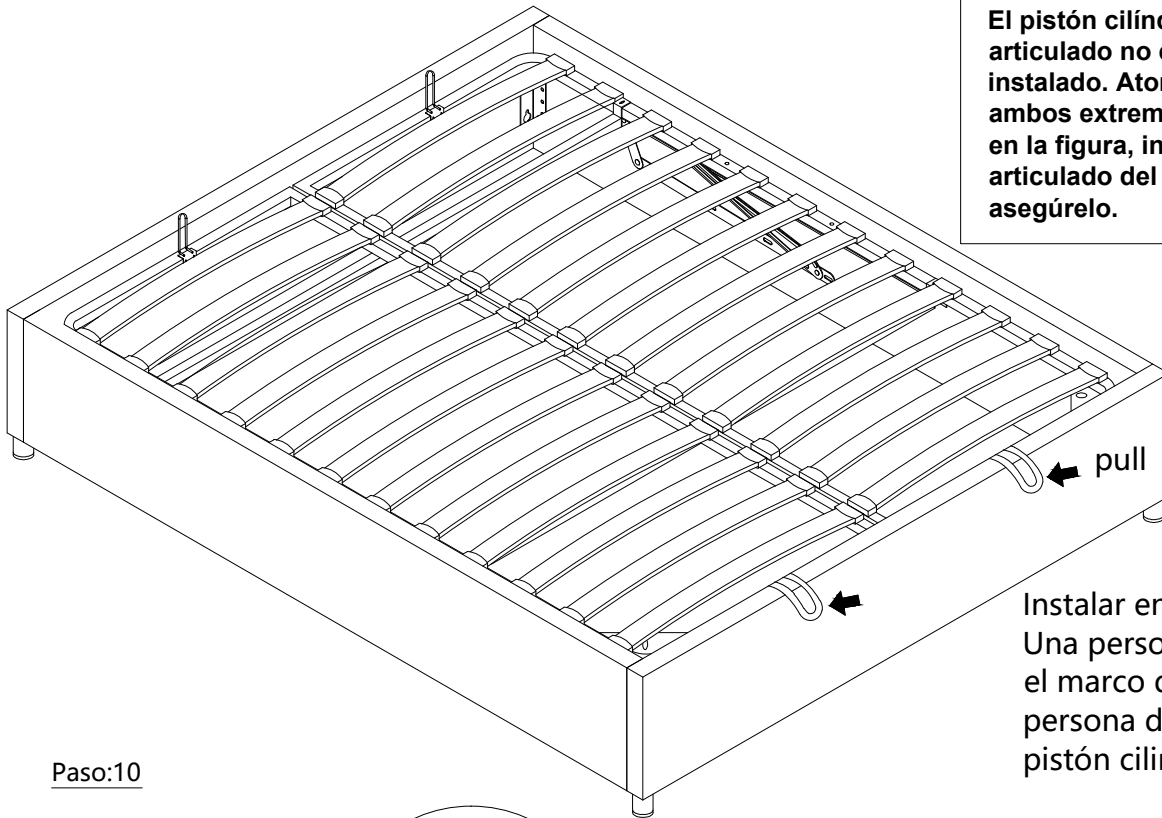

Instalar en dos personas, Una persona debe separar el marco de la cama y otra persona debe ensamblar el pistón cilindro.

Paso:10

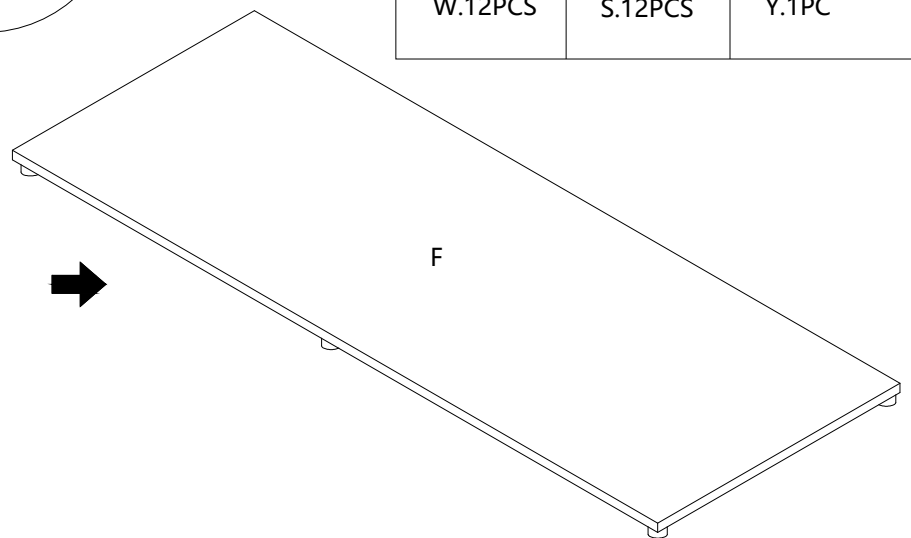
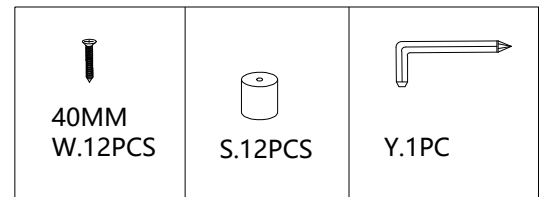
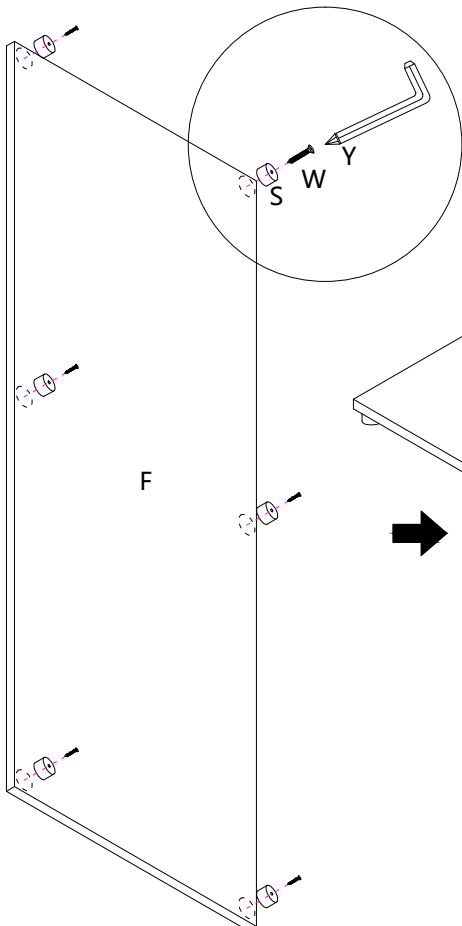

INSTRUCCIONES ARMADO

Paso:11

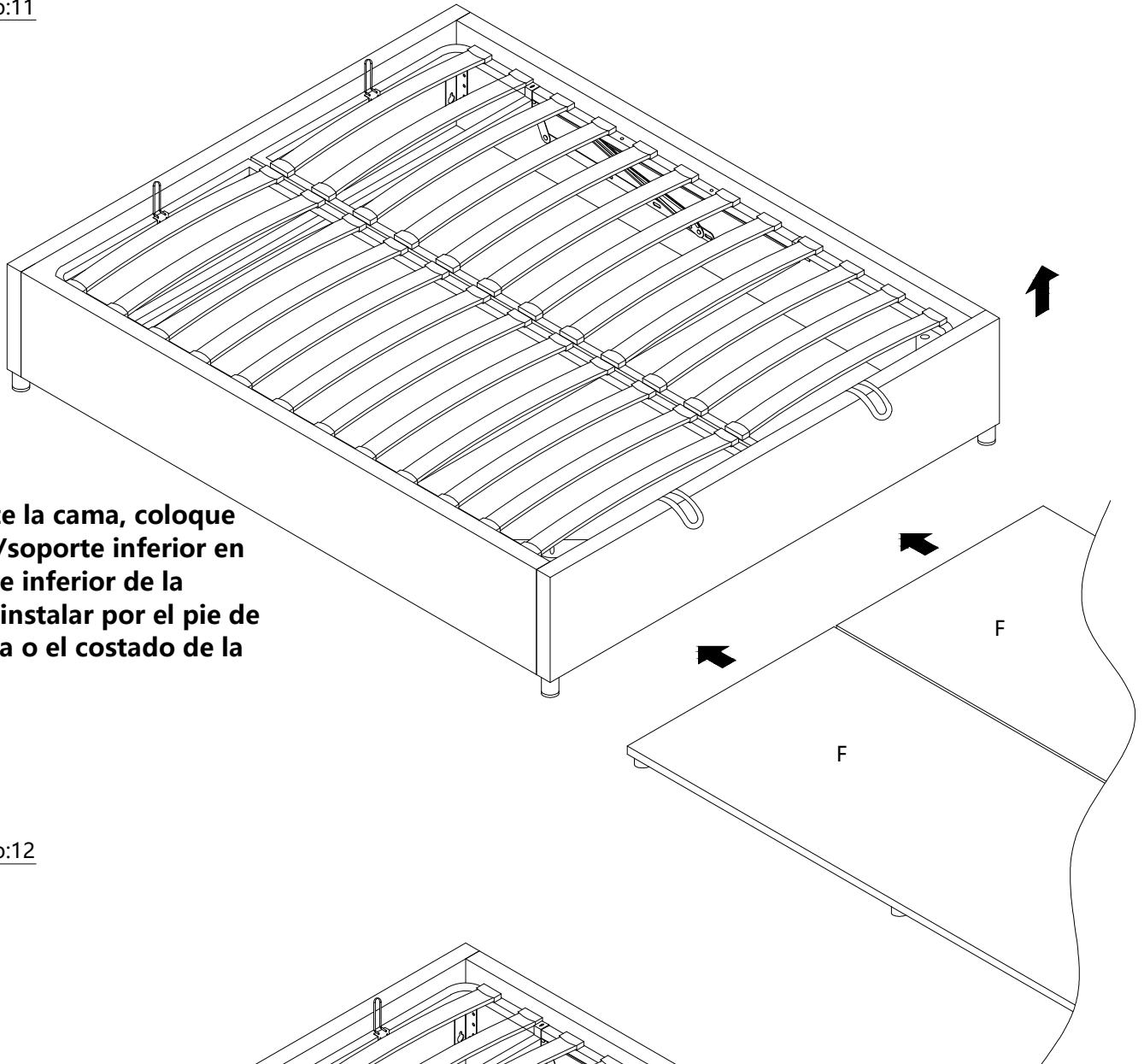

Levante la cama, coloque fondo/soporte inferior en la parte inferior de la cama, instalar por el pie de la cama o el costado de la cama

Paso:12

