

5 Montagem da Gaveta

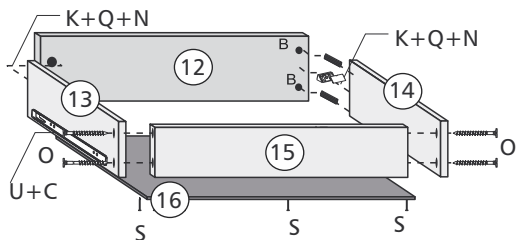

6 Montagem das Prateleiras de Vidro e Fixação na Parede

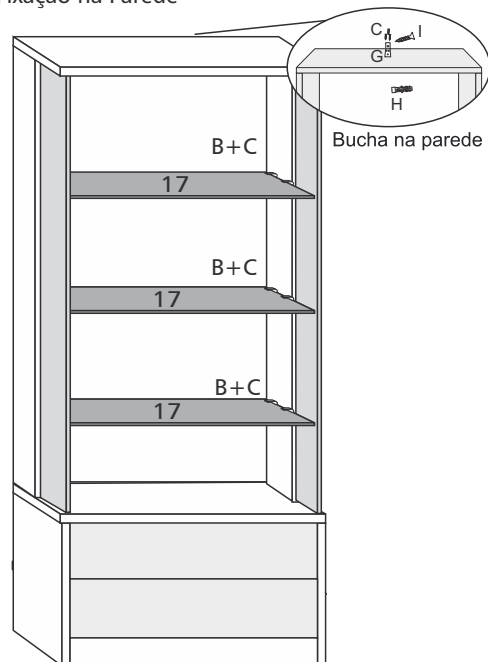

7 Montagem das Portas

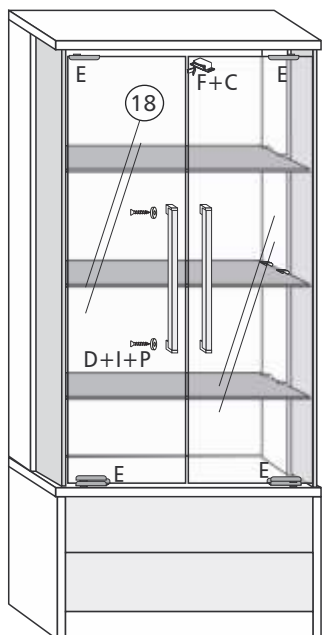

8 Aspecto Final

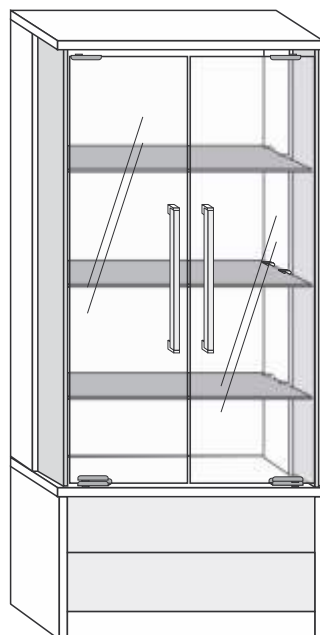

M Mavaular
MÓVEIS

Fone (32) 3539-7600
Rod. Ubá - Rodeiro, Km 03 - Galpão 1
C. P. 050 - CEP 36500-000 - Ubá - MG
E-mail: mavaular@mavaular.com.br - Site: www.mavaular.com.br

CRISTALEIRA DIAMANTE
Alt.: 1835 - Larg.: 710 - Prof.: 360
CÓDIGO: 5914



Atenção:
Antes de iniciar a montagem do produto, é aconselhável verificar o seguinte:

- Identifique e separe as peças;
- Inicie a montagem pelas sequência numérica de peças;
- O início da montagem deve ser feita com o produto deitado e sugerimos que seja utilizado a própria caixa para forrar o chão;
- Após montar o corpo do móvel, levante-o com a utilização de um esquadro, pregue as costa do produto.

Atención:
Antes de iniciar el montaje del producto, es recomendable comprobar lo siguiente:

- Identificar y separar las piezas;
- Iniciar la asamblea por el orden de numeración de las piezas;
- El inicio del montaje se debe hacer con la mentira de productos y sugieren que la propia caja se utiliza para cubrir el suelo;
- Después de configurar el cuerpo de la unidad, levantarlo con el uso de una plaza, pregar la costa del producto.











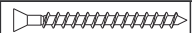









Attention:
Before starting the product assembly, it is advisable to check the following:

- Identify and separate the pieces;
- Start the assembly by the numerical sequence of parts;
- The beginning of the assembly should be done with the product lying and suggest that the box itself is used to cover the floor;
- After setting up the body of the unit, lift it with the use of a square, preach the coast of the product.

Lista de peças/Lista de piezas/Parts list

CÓD.	Nº	PEÇAS	PARTES	PARTS
6142	01	Lateral Inferior Direita	Lateral inferior derecho	Right Bottom Lateral
6148	02	Rodapé Frontal	Pie de página delantero	Front Footer
6149	03	Rodapé Traseiro	Pie de página trasero	Rear Footer
6147	04	Vista da Gaveta	Vista de cajones	Drawer View
6597	05	Lateral Inferior Esquerda	Izquierda Inferior Izquierda	Left Bottom Left
6139	06	Lateral Superior	Lado superior	Upper Side
6141	07	Tampo Gaveteiro	Cajón Superior	Top Drawer
4512	08	Lateral de Vidro	Lado de vidrio	Panel with Mirror
6150	09	Painel com Espelho	Panel con espejo	Gaveteiro Coast
6344	10	Costa do Gaveteiro	Costa Gaveteiro	Glass Side
6140	11	Tampo Superior	Tabla superior	Top Table
6144	12	Frente de Gaveta	Frente del cajón	Drawer Front
6145	13	Lateral Direita Gaveta	Cajón lateral derecho	Right Side Drawer
6598	14	Lateral Esquerda Gaveta	Cajón lateral izquierdo	Left Side Drawer
6146	15	Traseiro Gaveta	Cajón trasero	Rear Drawer
6151	16	Fundo Gaveta	Fondo de cajones	Drawer Background
4434	17	Prateleira de Vidro	Estante de vidrio	Glass Shelf
6348	18	Porta de Vidro	Puerta de vidrio	Glass door

Lista de Acessórios/Lista de Accesorios/List of Accessories

ACESSÓRIOS	ACCESRIOS	ACCESORIES		QTD.
A Paraf.4x50	Para.4x50	Para. 4x50		08
B Boca Jacaré	Boca de cocodrilo	Alligator Mouth		12
C Paraf.3,5x14 chap.	Para.3,5x14 cap.	Para.3,5x14 chap.		45
D Arruela Cilicone	Lavadora de cilindro	Cylinder Washer		04
E Dobradiça Vidro	Bisagra de vidrio	Glass Hinge		02
F Fecho Imã	Cerradura de imán	Magnet Lock		01
G Cantoneira	Ángulo	Angle		01
H Bucha 8mm	Buje de 8 mm	Bushing 8mm		01
I Parafusa 4,8x45	Tornillo 4.8x45	Screw 4.8x45		01
J Luminária	Lampara	Light fixture		01
K Conector	Conector	Connector		06
L Paraf.3,5x14 Flang.	Para.3,5x14 Flang.	Para.3,5x14 Flang.		24
M Paraf.3,5x16	Para.3,5x16	Para.3,5x16		04
N Tapa Furo Adesivo	Pegatina Agujero de bofetada	Slap Hole Sticker		16
O Paraf.3,5x30	Para.3,5x30	Para.3,5x30		14
P Parafuso 4x40	Tornillo 4x40	4x40 screw		10
Q Cavilha 6x30	Pin 6x30	6x30 pin		14
R Sapata L	Zapato L	Shoe L		04
S Prego 10x10	Clavo 10x10	Nail 10x10		30
T Puxador	Manejar	Puller		02
U Corrediça Telescópica	Tobogán telescópico	Telescopic slide		02

1 Início da Montagem

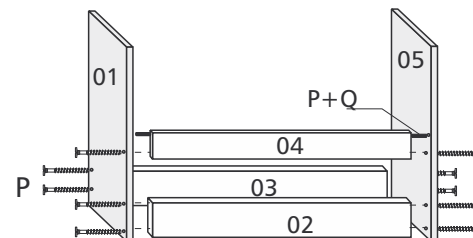

2 Montagem do tampo e da lateral.

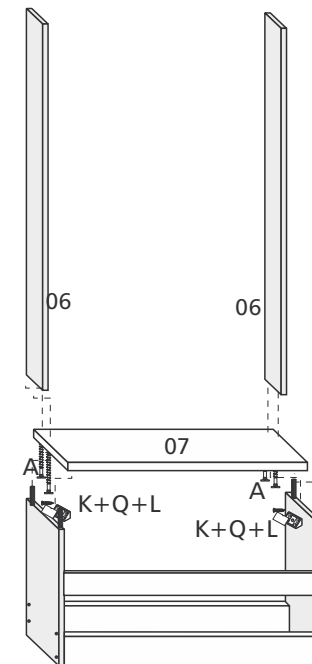

3 Montagem das laterais de vidro.

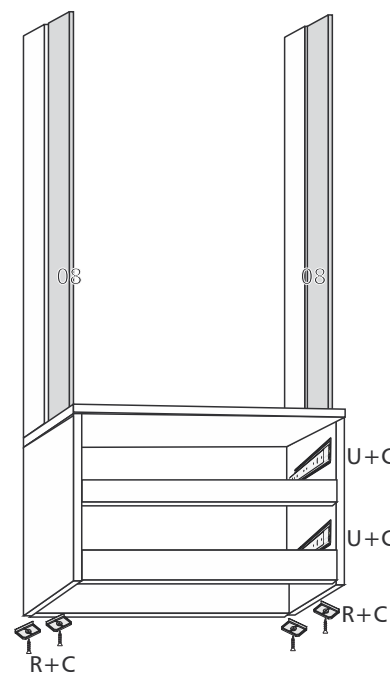

4 Montagem do painel, das costas e do tampo

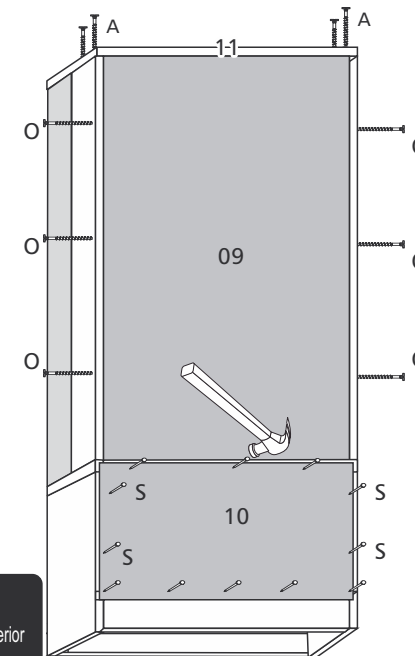

Obs.: Sr. Montador
Fixar as costas com o
acabamento para o exterior
do produto.