

# INSTRUÇÕES DE MONTAGEM INSTRUCCIONES DE ARMADO ASSEMBLY INSTRUCTIONS

**REF.: MP3044/  
L3044**

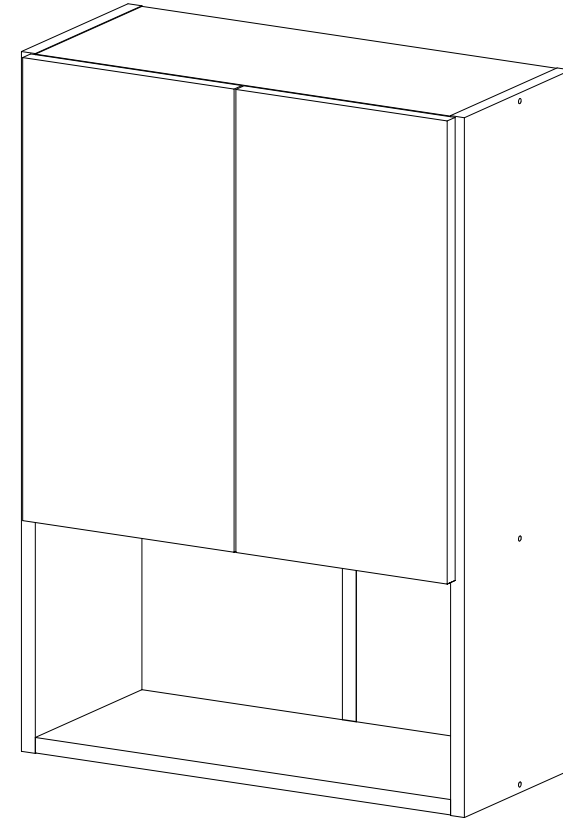

**OBRIGATÓRIO FIXAR NA PAREDE  
OBLIGATORIO DE FIJAR EN LA PARED  
MANDATORY TO FIX ON THE WALL**

FERRAMENTAS NECESSÁRIAS  
HERRAMIENTAS NECESARIAS  
TOOLS NECESSARY

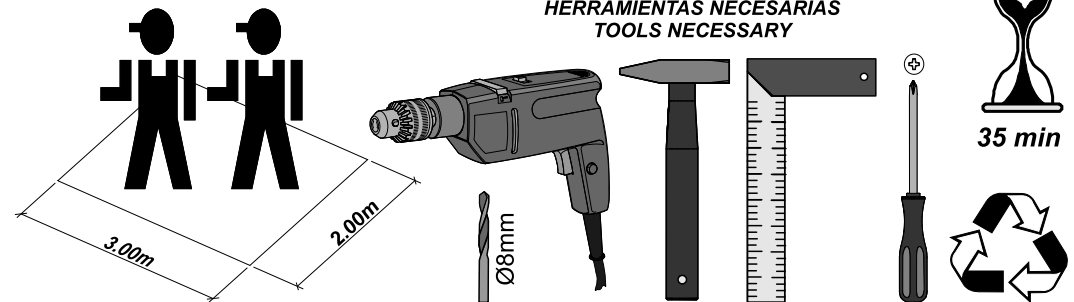

Ref.:MP3044/L3044 - 24/Maio/2021 - Rev. 03

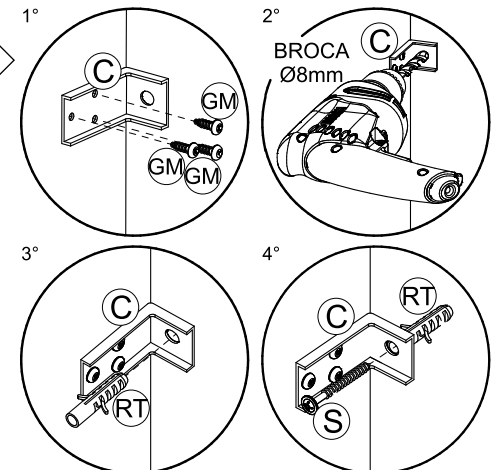
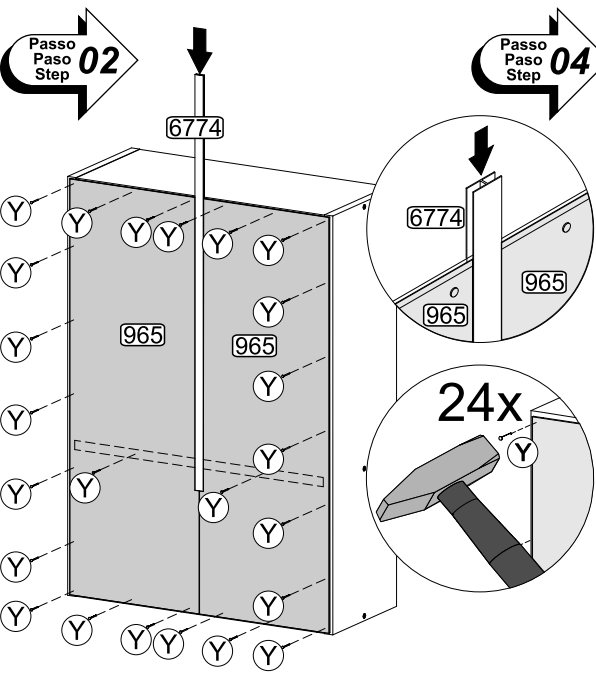

Primeiro deve-se fixar os suportes aéreos (C) conforme detalhe 1° depois disso, tem que ser feito as furações na parede onde o suporte irá ser fixado. Para furar a parede deve-se posicionar o móvel na parede na altura desejada, e com o auxílio de uma furadeira e uma broca Ø8mm, furar através suporte aéreo (C), após isso, colocar as buchas (RT) nos furos que foram feitos e por fim, fixar o móvel na parede com os parafusos (S).

Primero, los soportes aéreos (C) deben fijarse según el detalle 1°, después de eso, tendrá que perforar agujeros en la pared donde se fijará el soporte. Para perforar la pared, debes posicionar los muebles en la pared a la altura deseada, y con la ayuda de un barrena Ø8mm, taladrar a través del soporte aéreo (C), después de eso, coloque los casquillos (RT) en los orificios que se perforo y finalmente fijar el mueble a la pared con los tornillos (S).

First, the aerial supports (C) must be fixed according to detail 1°, after that you will have to drill holes in the wall where the bracket will be fixed. To pierce the wall, you must position the furniture on the wall at the desired height, and with the help of a Ø8mm bit, drill through the aerial bracket (C), after that, put the bushings (RT) into the holes to be drilled and finally fix the furniture to the wall with the screws (S).

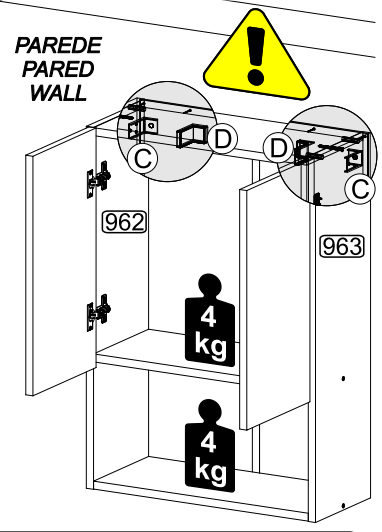
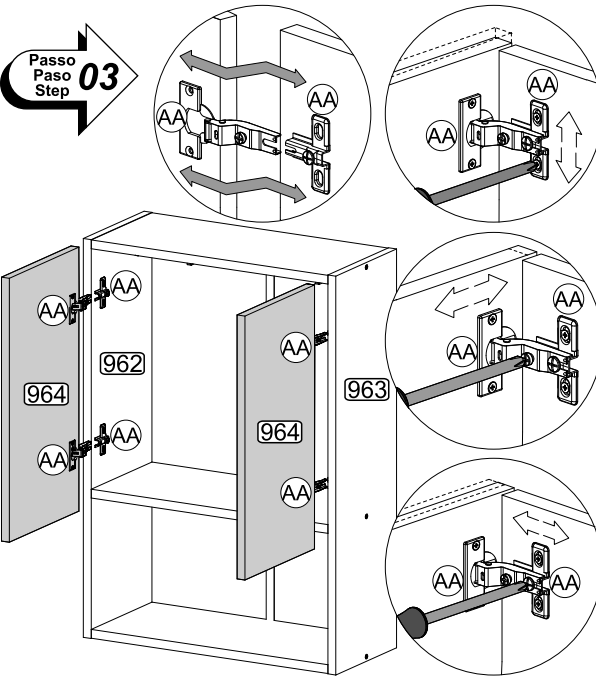









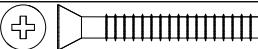

**OBRIGATÓRIO FIXAR NA PAREDE  
OBLIGATORIO DE FIJAR EN LA PARED  
MANDATORY TO FIX ON THE WALL**

IMAGEM ILUSTRATIVA MP3044

# LISTA DE FERRAGENS / LISTA DE MATERIALES / HARDWARE LIST

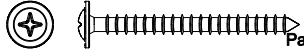
# PRÉ-MONTAGEM / PRÉ-ARMADO / PRÉ-ASSEMBLAGE

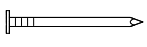
A		Tampa Adesiva	06	D		Capa p/ Suporte Aéreo	02
AA		Dobradiça	04	GM		Paraf. 3,5 x 14	06
B		Paraf. 4,5 x 50	06	H		Cavilha 8,0 x 30	12
BX		Bisnaga de cola 5gr	01	RT		Bucha Ø8mm	02
C		Suporte Aéreo	02	S		Paraf. 5,0 x 45	02
CC		Paraf. 3,5 x 14	16	Y		Prego 10 x 10	24

## Utilizar a régua abaixo para medir as ferragens:

Utilizar la regla abajo para medir los herrajes: Use the ruler below to measure the hardware:

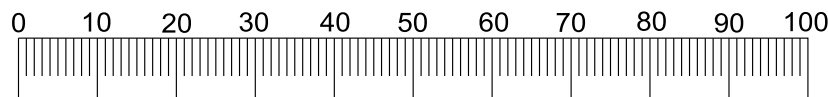

Medidas em mm / Medidas en mm / Measurements in mm



**Senhor montador!**  
Informamos que a numeração das peças encontra-se no topo das mesmas conforme desenho acima.



**Señor Armador!**  
Les informamos que la numeración de las piezas encuentranse arriba de las mismas, de acuerdo al modelo arriba.

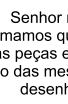

**Dear Assembler!**  
We inform you that the number of each piece is located on the top of it, according to the model shown above.

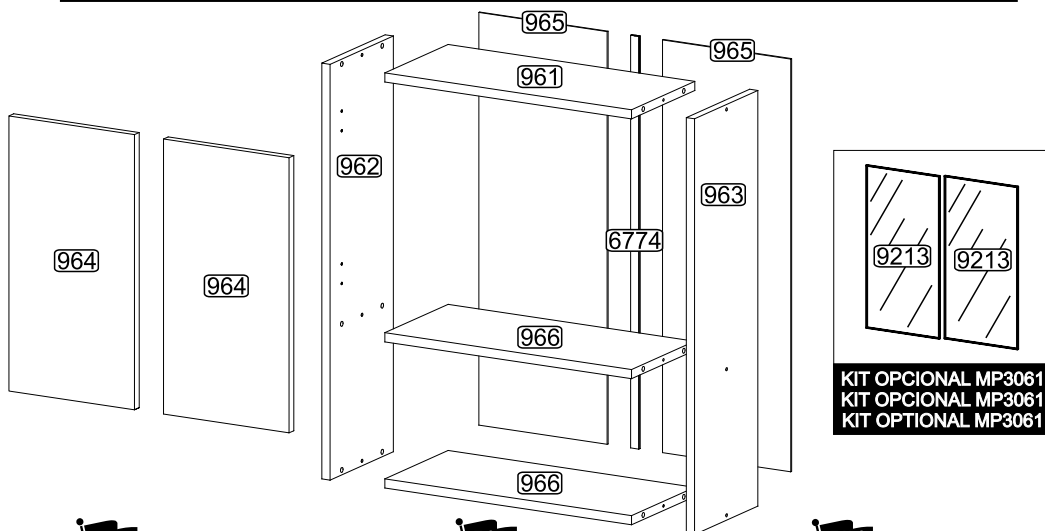

<b>POR</b>	<b>LISTA DE PEÇAS</b>	<b>ESP</b>	<b>LISTA DE PIEZAS</b>	<b>ENG</b>	<b>PART LIST</b>
Nº	DENOMINAÇÃO	Nº	DENOMINACIÓN	Nº	DESCRIPTION
961	TAMPO	961	TAPA	961	TOP
962	LATERAL ESQUERDA	962	LATERAL IZQUIERDA	962	LEFT SIDE
963	LATERAL DIREITA	963	LATERAL DERECHA	963	RIGHT SIDE
964	PORTA	964	PUERTA	964	DOOR
965	COSTA	965	RESPALDO	965	BACK
966	PRATELEIRA	966	ESTANTE	966	SHELF
6774	PERFILI	6774	PERFIL I	6774	I PROFILE
9213	ESPELHO	9213	ESPEJO	9213	MIRROR

