

ESCRITORIO ESTANTERÍA Z120

Z120 Shelf desk

Bureau étagère Z120

REF. EBD 7433

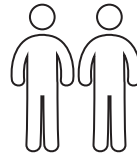

90min

INSTRUCCIONES DE ARMADO

ASSEMBLY INSTRUCTION

INSTRUCTIONS DE MONTAGE

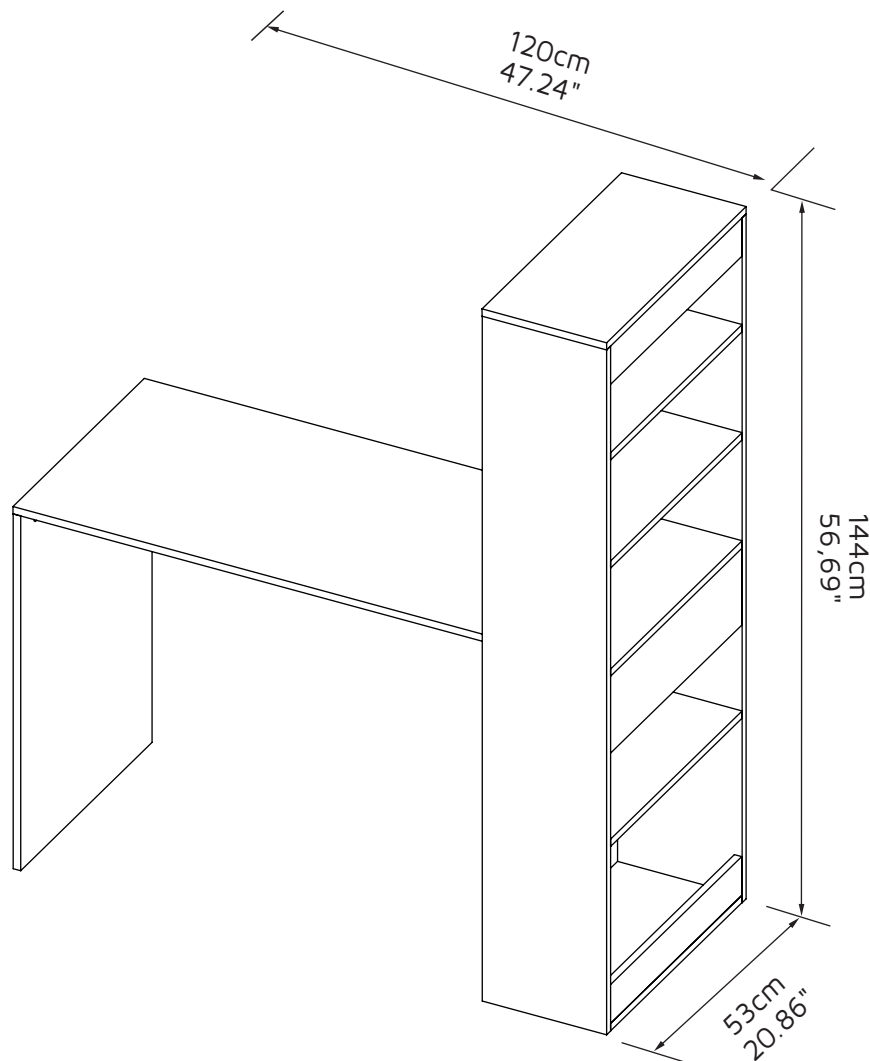

Si alguna pieza está rota o falta, por favor contáctenos en:
customerservice@tuhome.com.es

Nuestro equipo de atención al cliente te brindará ayuda
para resolver cualquier problema de inmediato.

If any part of the product is broken or missing, please contact us in :
customerservice@tuhome.com.es

Our customer service department will support you
in order to solve any issue as soon as possible.

Si une pièce est cassée ou manquante, veuillez nous contacter à :
customerservice@tuhome.com.es

Notre équipe du service clientèle vous aidera
à résoudre tout problème immédiatement.

LOT N°

¿Por dónde empezamos?

¡Esto es muy IMPORTANTE!

En las próximas páginas está el contenido de las piezas y herrajes del mueble.

Asegúrate de que la cantidad de herrajes y piezas que hay en la caja sea la correcta y todo esté en buen estado.

(Ya que cuando el mueble esté armado no podrás realizar ninguna reposición)

Where should you start?

This is so IMPORTANT!

Over the next few pages is the panel and hardware content for this cabinet.

Please make sure that the quantity of each one is correct, and that everything is in good shape.

(When the cabinet is already assembled there's no warranty for this)

Par où commencer?

Ceci est très IMPORTANT!

Dans les pages suivantes se trouve le contenu des pièces et garnitures du meuble.

Vérifier que la quantité de pièces et de garnitures présents dans la boîte est correcte et que tout est en bon état.

(Lorsque l'armoire sera assemblée, aucun pièce ne pourra être remplacée)

Qué vamos a necesitar?

Destornillador de estrella.



Destornillador de pala.

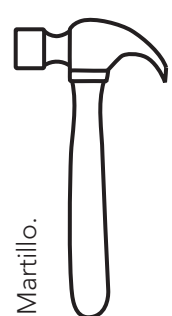

Martillo.

Una superficie plana y lisa, puedes utilizar el cartón de la caja del mueble o sobre un tapete.

Un destornillador eléctrico no es necesario, pero podría facilitarte el trabajo.

What will you need?

Phillips head screwdriver



Flat head screwdriver

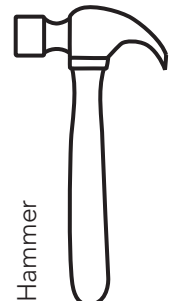

Hammer

A flat, smooth surface. You can use the cardboard of the box or a rug.
An electric screwdriver isn't necessary, but it can make the work much easier.

De quoi aurons-nous besoin?

Tournevis cruciforme.



Tournevis à tête plate.

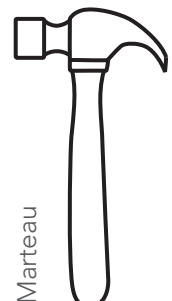

Marteau

Une surface plane et lisse. Vous pouvez utiliser le carton de la boîte ou un tapis.
Un tournevis électrique n'est pas nécessaire, mais il peut rendre le travail beaucoup plus facile.

HERRAJES DE ARMADO

Assembly Hardware

Matériel D'assemblage

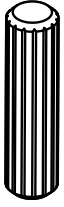

x30

Tarugo
Wood Dowel/
Cheville en bois.

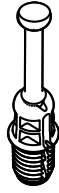

x31

Perno Minifix
Spreading Bolt/
Boulon d'écartement



x31

Minifix
Minifix Cams/
Cames Minifix



Color 1
x23

Tapa Adhesiva Minifix
Cover Caps/
Plaques de
couverture/Cache

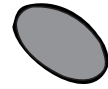

Color 2
x10

Tapa Adhesiva Minifix
Cover Caps/
Plaques de
couverture/Cache

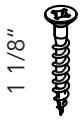

x3

Tornillo ensamble
Drywall Srew/
Vis à cloison sèche



x8

Tornillo lámina
Flat head Screw/
vis à tête plate

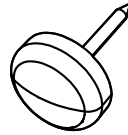

x6

Deslizador Puntilla
Nail-on Glide/
Fixation par clouage

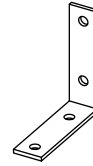

x2

Platina en Ángulo
Angle Brackets
Équerres d'angle

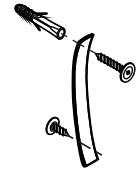

x2

Kit Antivuelco
(Tornillos incluidos)
Wall Fixing Kit
(Screws Included) /
Kit de Fixation Murale
(Vis incluses)

PIEZAS DE ARMADO

Assembly Parts

Pièces De Montage

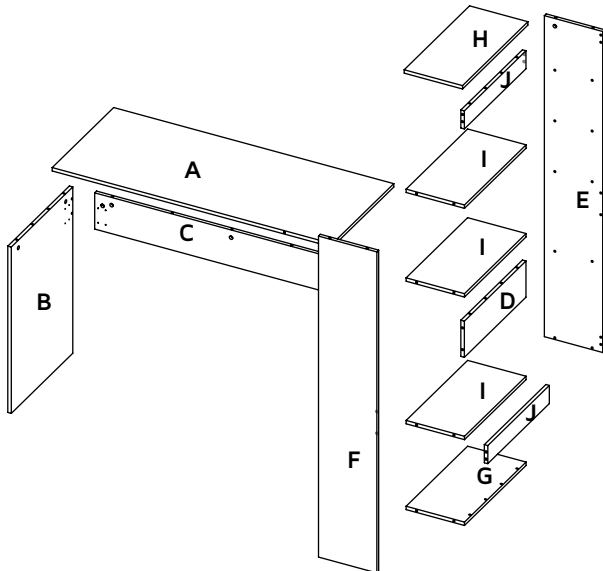

A - x1	E - x1	I - x3
B - x1	F - x1	J - x2
C - x1	G - x1	
D - x1	H - x1	

CARGAS MÁXIMAS SUGERIDAS

Max Suggested Load

Charges Maximales Recommandées

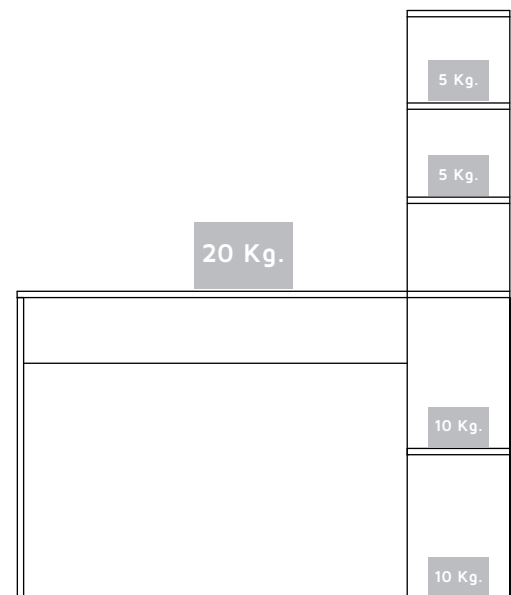

Cómo funcionan los tarugos y minifix?

¡IMPORTANTE!

Cada vez que vaya a utilizar uno de estos durante el armado, sigue los pasos que te indicamos aquí.

Tarugo

Son pequeños cilindros de madera.

1

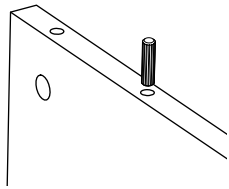

Inserta el tarugo en la perforación indicada y golpéalo suavemente hasta que llegue hasta el final de la perforación.

2

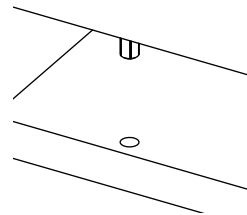

Al unir dos piezas, no olvides golpear un poco las piezas para ajustar el ensamble.

Minifix

Es un pequeño sistema de unión que se compone de dos partes: una caja minifix y un perno.

1

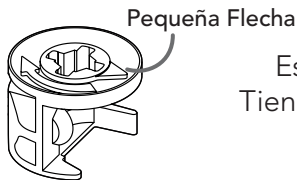

Esta es una caja minifix. Tiene una pequeña flecha en su parte superior.

3

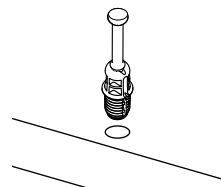

Este es un perno. Debes insertarlo con la parte plástica hacia abajo.

2

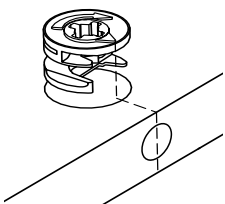

Debes insertar las cajas minifix con la flechita apuntando hacia la perforación que hay en el borde de la pieza.

4

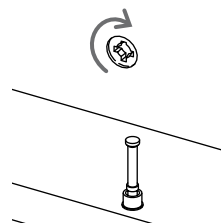

Luego de unir las piezas, debes girar 180° las cajas minifix con un destornillador de estrella para ajustar y asegurar el ensamble.

How do the dowels and Minifix system work?

This is so important too!

Everytime you're using one of these connectors during the assembly, you should follow these same steps.

Wood dowels

They are little wooden cylinders.

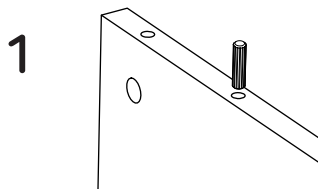

Put in the dowel inside the indicated hole and softly hit it until it's fully inside.

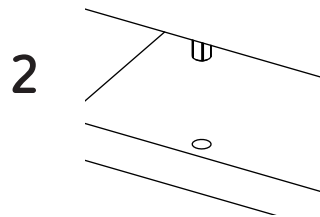

When joining two panels together, don't forget to gently hit the panels to adjust the joint.

Minifix system

It's a joint compound of two parts: a spreading bolt and a Minifix cam.

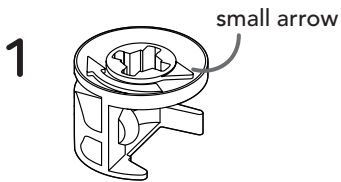

This is a Minifix cam. It has a little arrow on its upper surface.

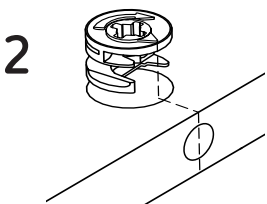

You should insert these cams with the little arrow pointing towards the drilling on the panel's edge (shown on the left).

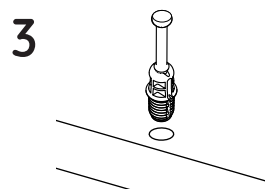

This is a spreading bolt. You should put it with the black plastic part facing down.

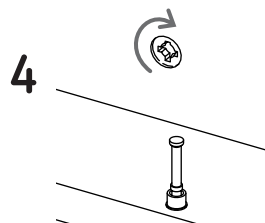

After joining two panels together you should turn the cams 180° with a phillips head screwdriver to adjust and secure the joint.

Comment fonctionnent les chevilles et le système Minifix?

C'est tellement important aussi!

Chaque fois que vous allez les utiliser pendant le montage, suivez les étapes que nous vous indiquons ici.

Cheville

Ce sont de petits cylindres en bois.

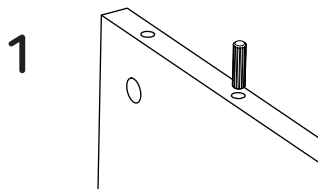

Insérer la cheville dans l'orifice indiqué en donnant de petits coups, l'enfoncer jusqu'au fond de l'orifice

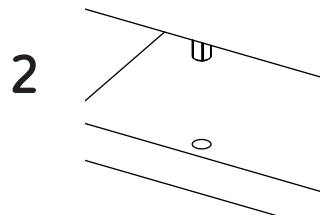

Lorsque vous assemblez deux pièces, n'oubliez pas de taper doucement sur celles-ci pour ajuster l'assemblage.

Minifix

Il s'agit d'un petit système d'union composé de deux parties : une Came Minifix et un boulon.

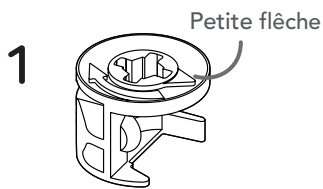

Ceci est une Came Minifix. Il y a une petite flèche sur la partie supérieure.

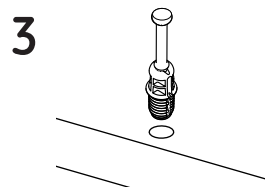

Ceci est un boulon. Il doit être inséré avec sa partie en plastique vers le bas

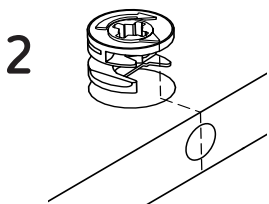

Les Cames minifix doivent être insérées avec la petite flèche vers l'orifice qui se trouve sur le bord de la pièce.

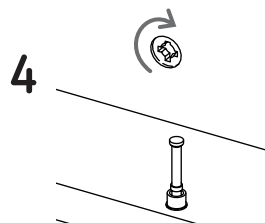

Après avoir uni les pièces, il faut visser à 180° les cames minifix avec un tournevis cruciforme pour ajuster et fixer l'assemblage

1

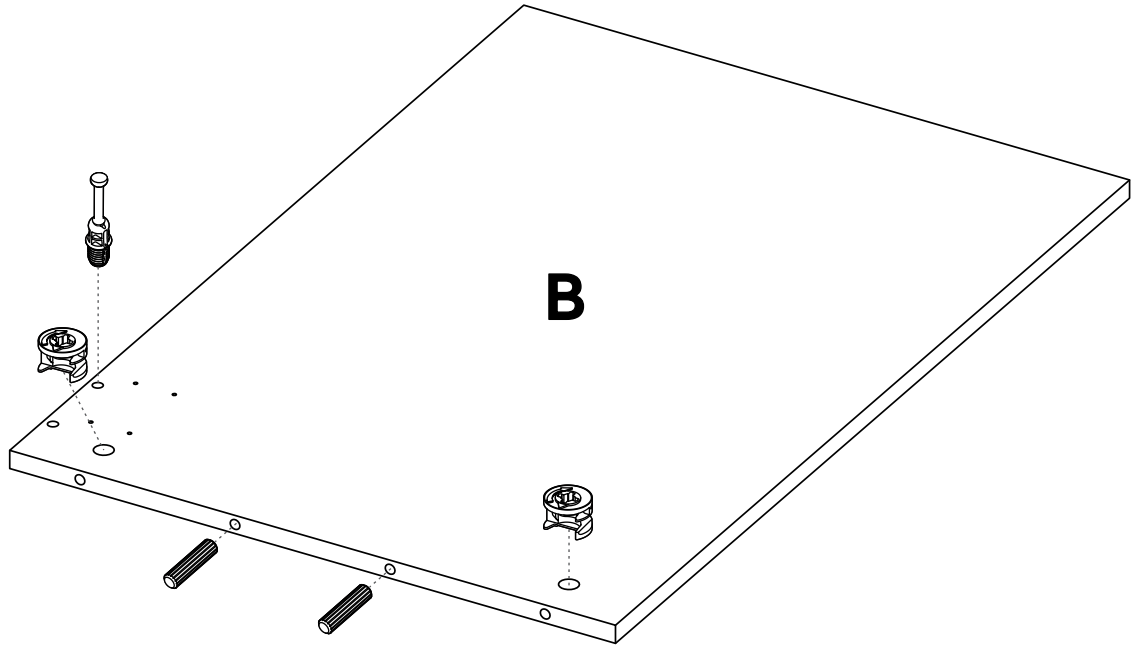

2

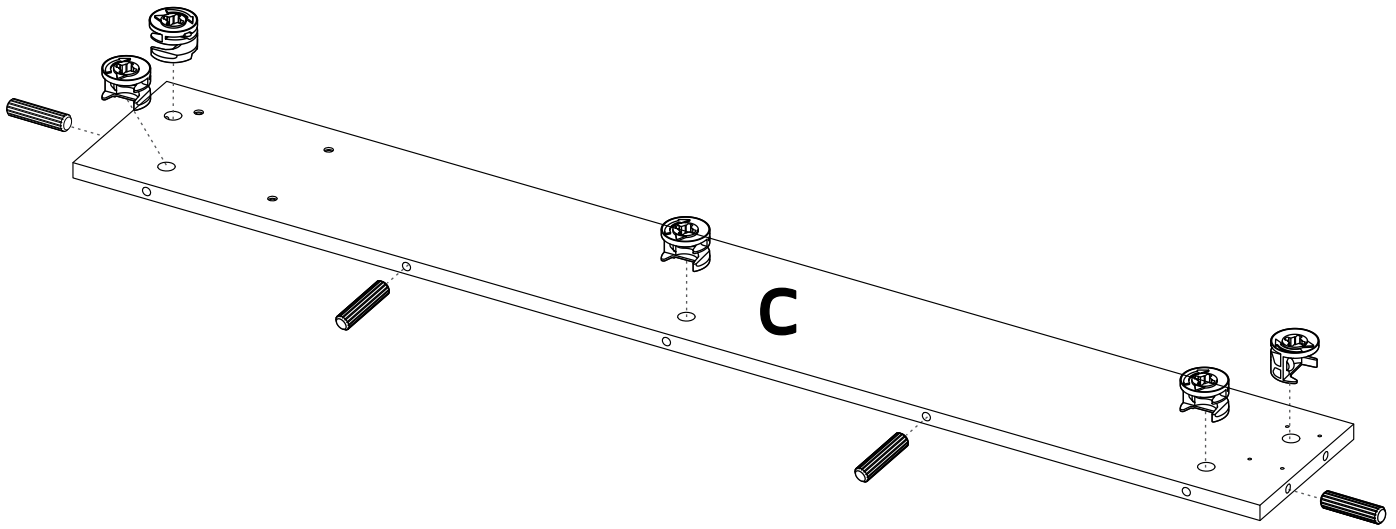

3

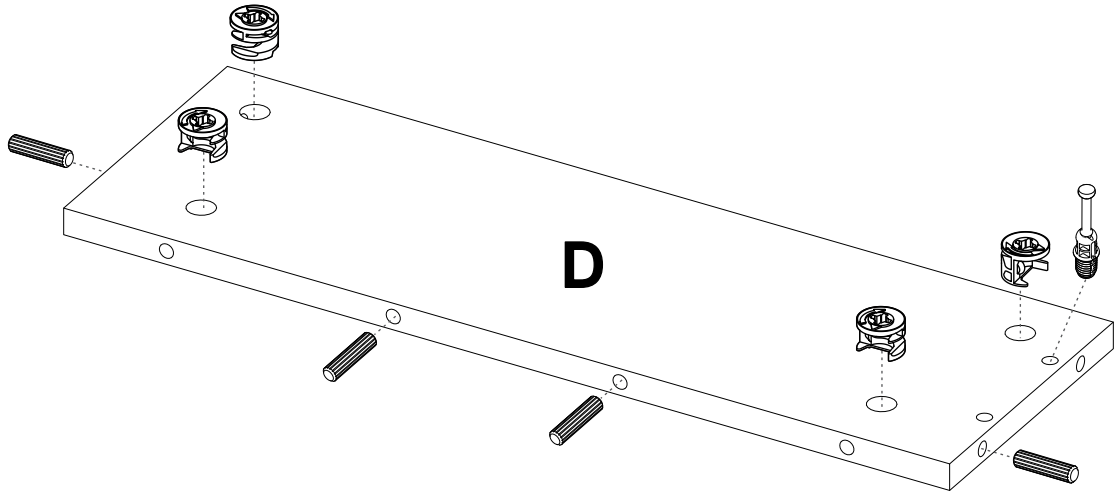

4

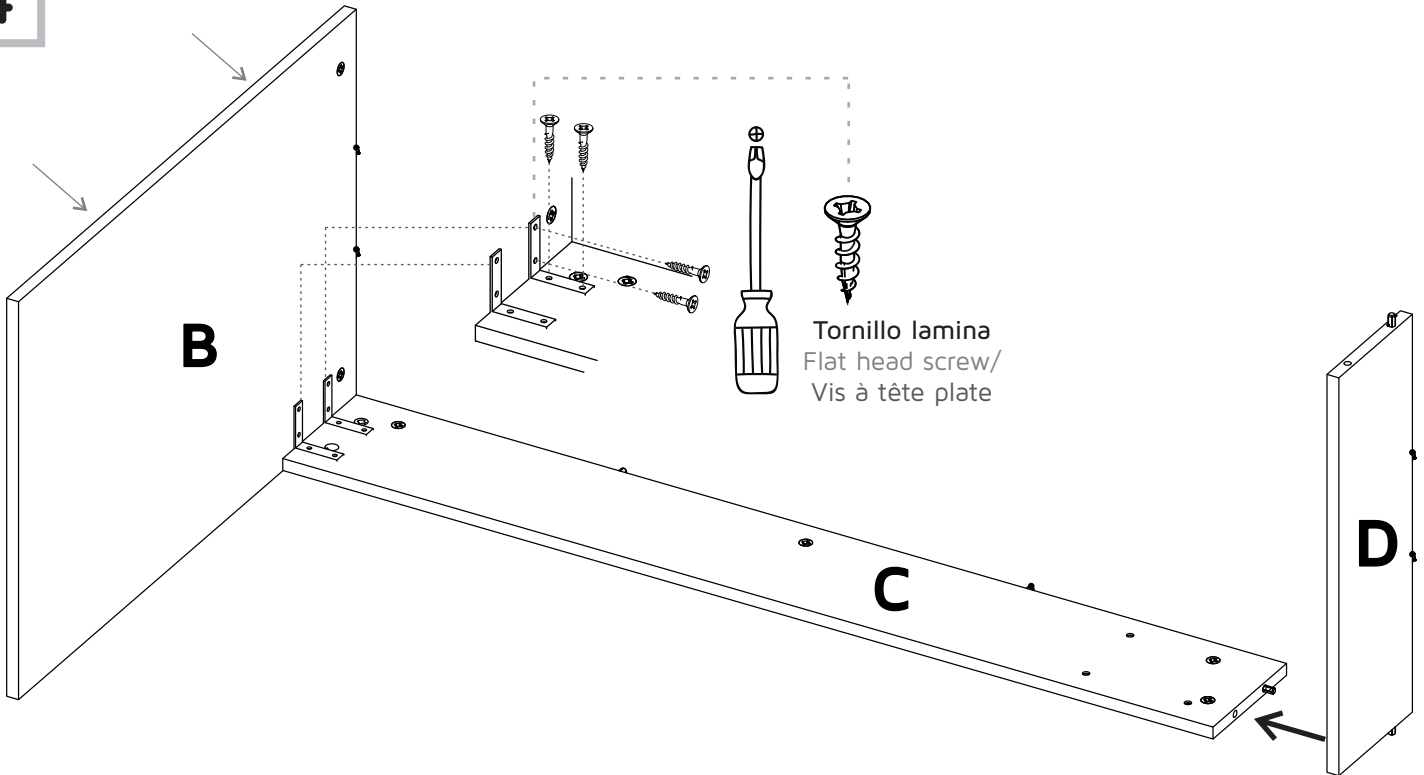

5

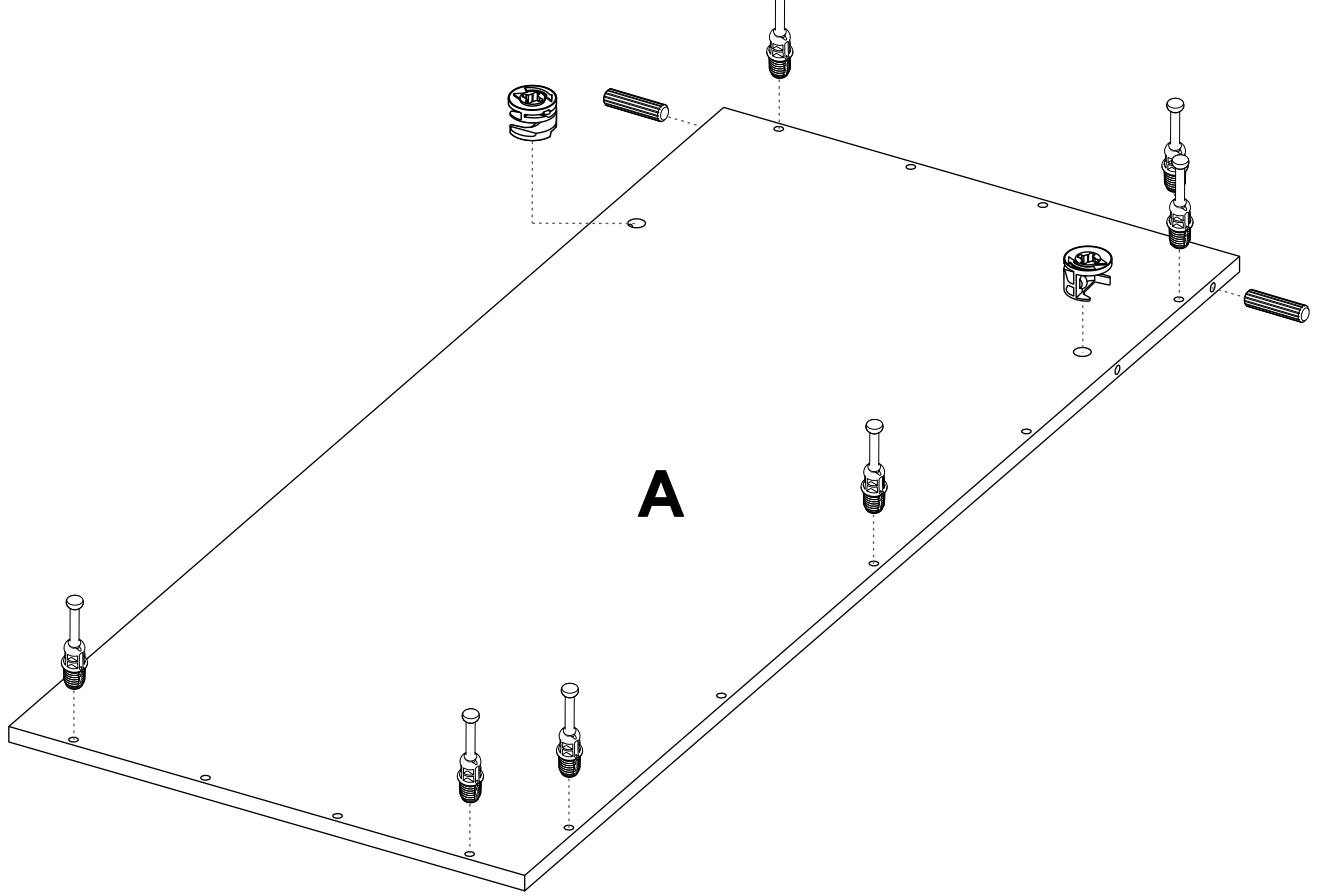

6

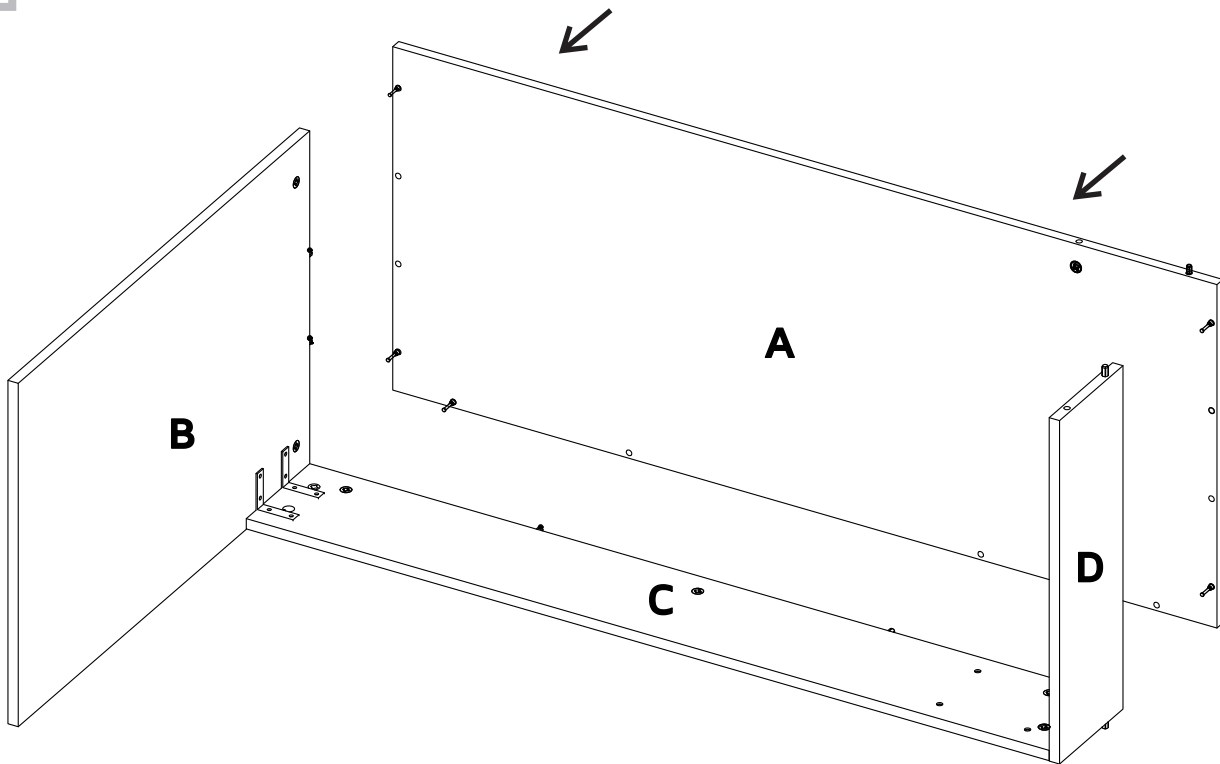

7

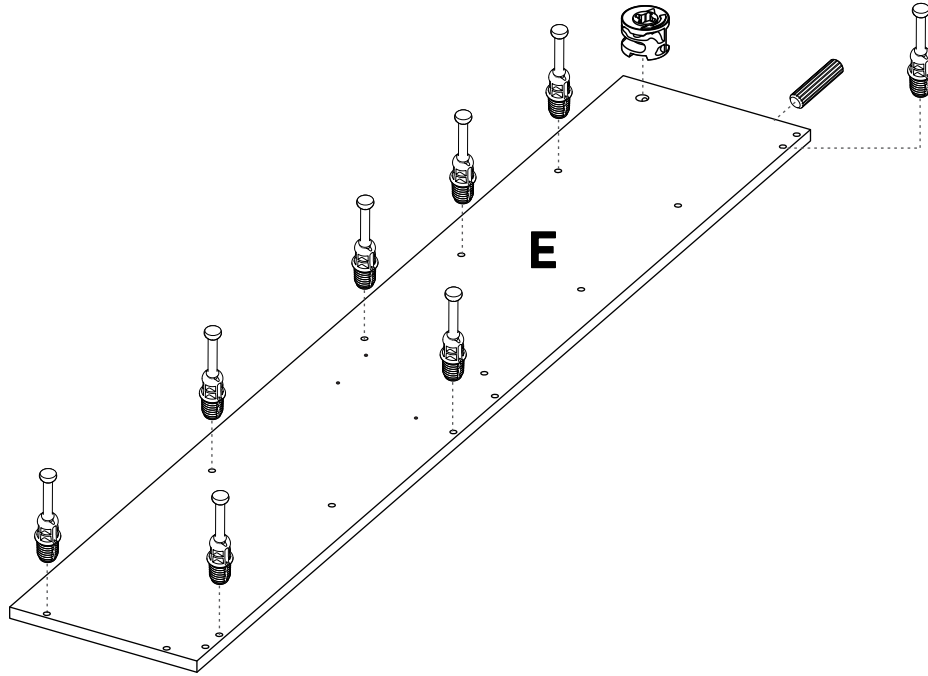

8

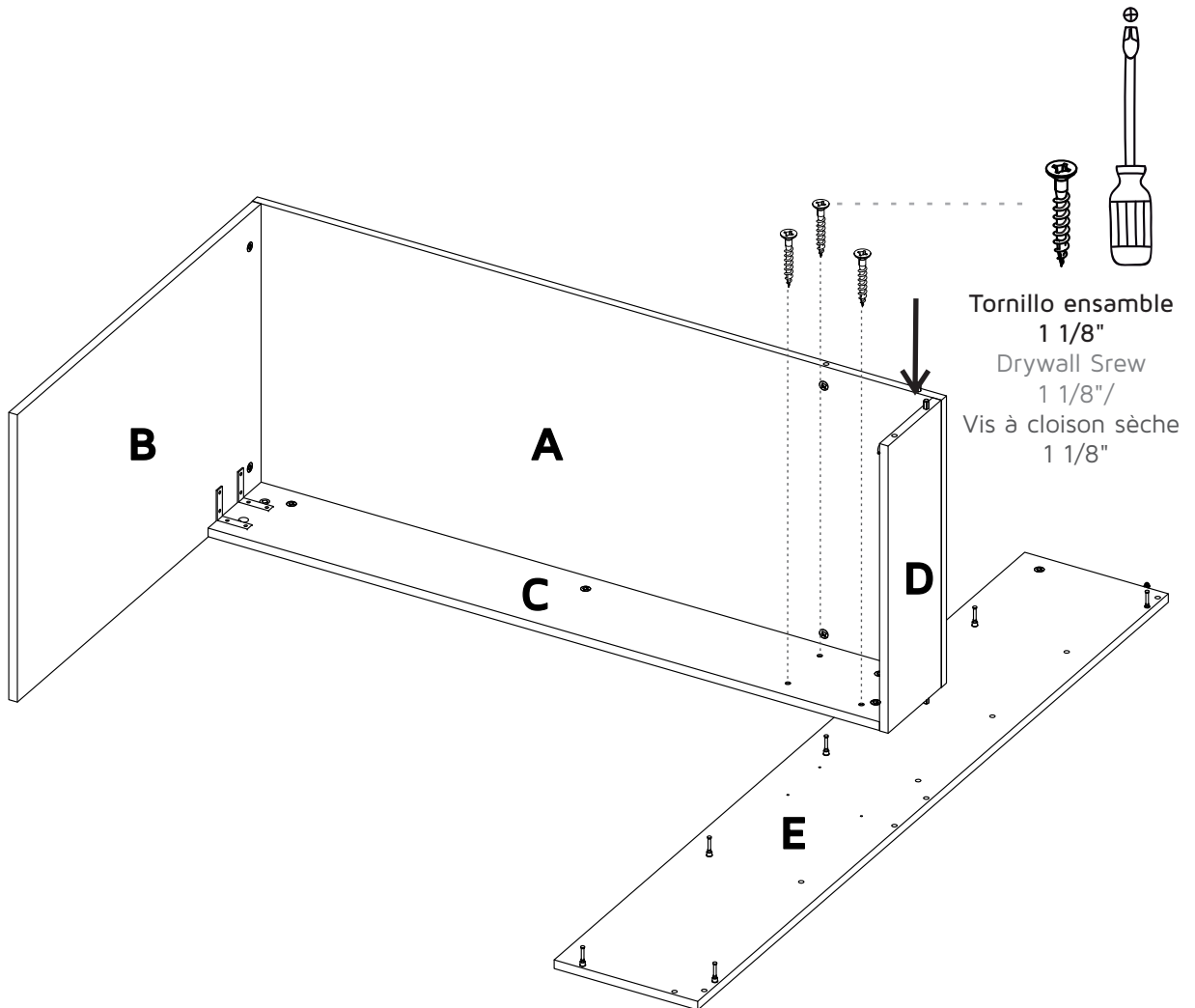

9

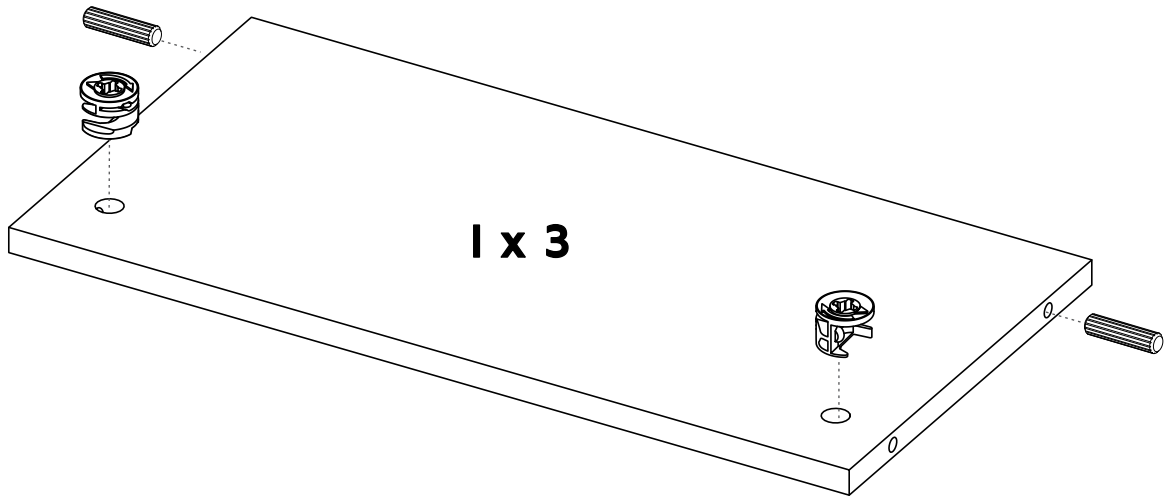

10

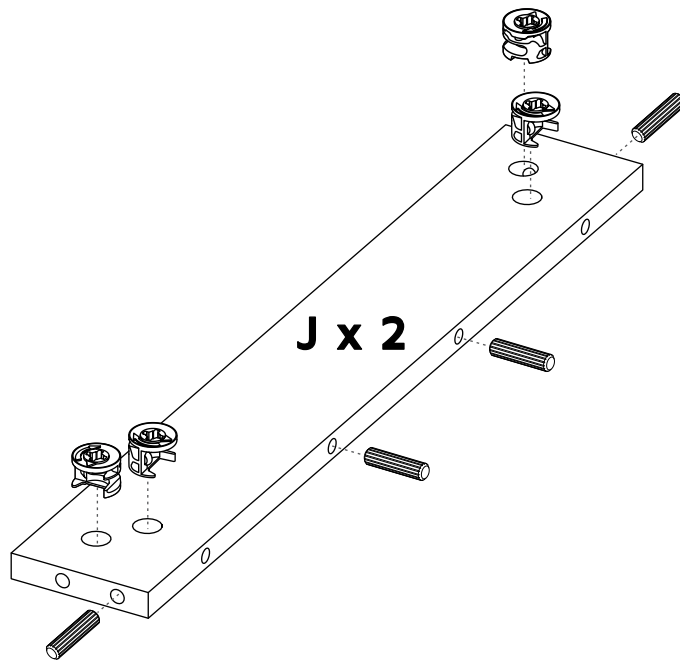

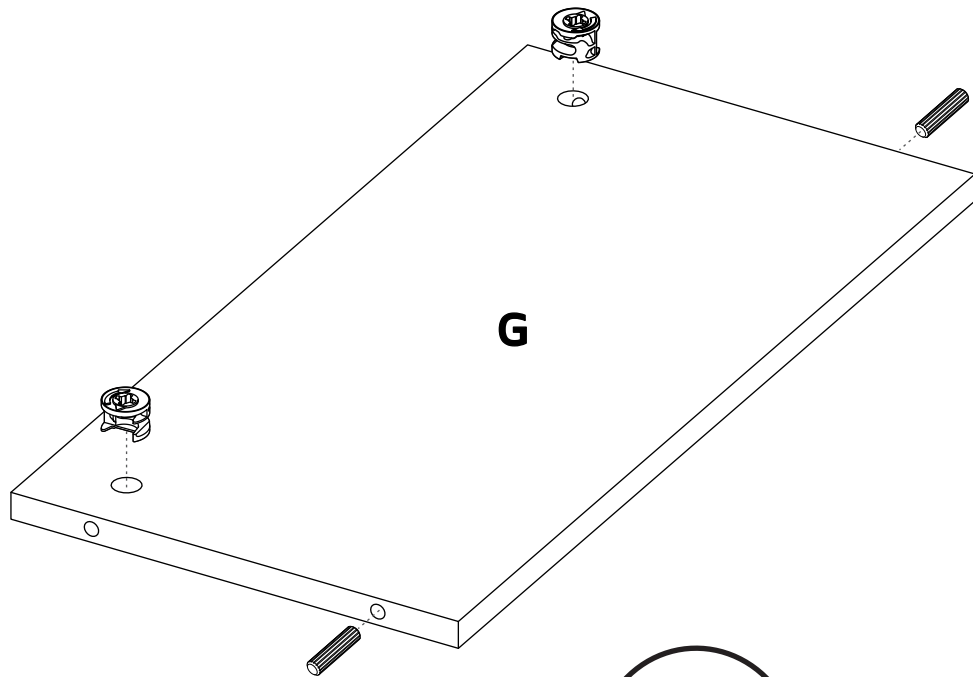

Voltear
Rotate/Tourner

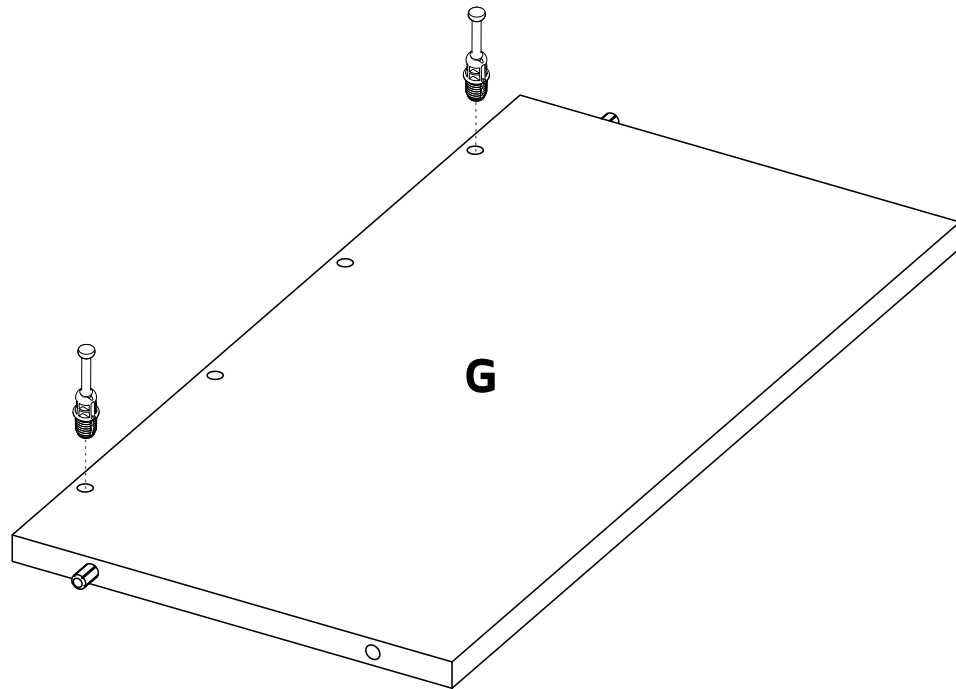

12

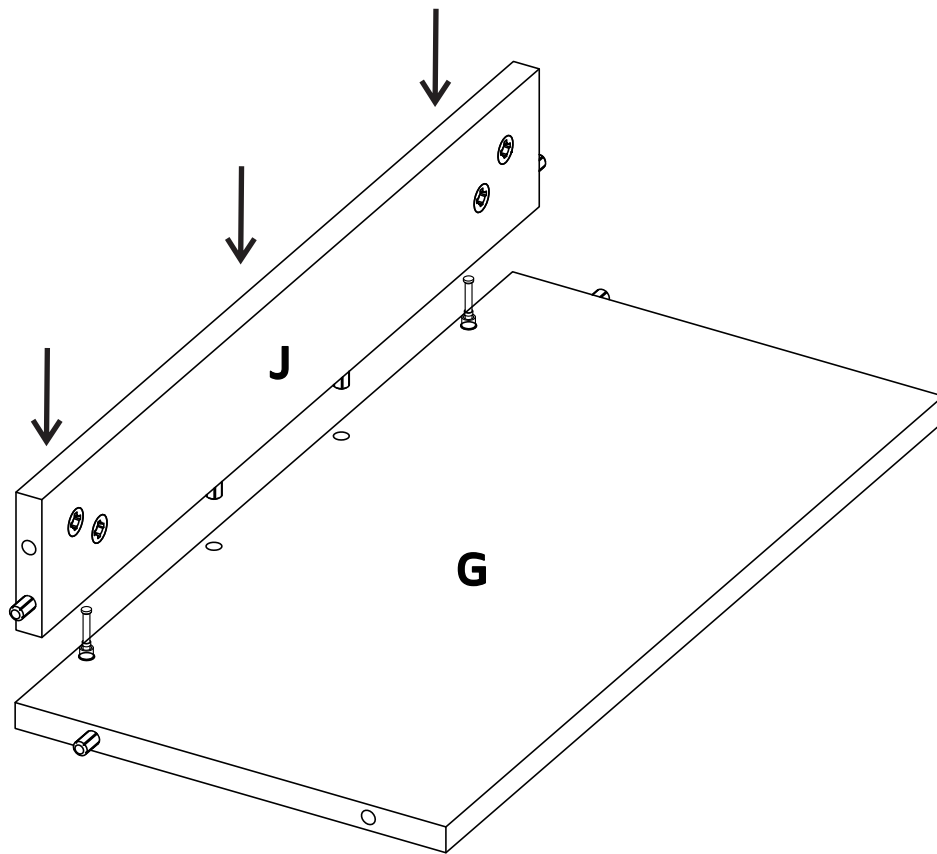

13

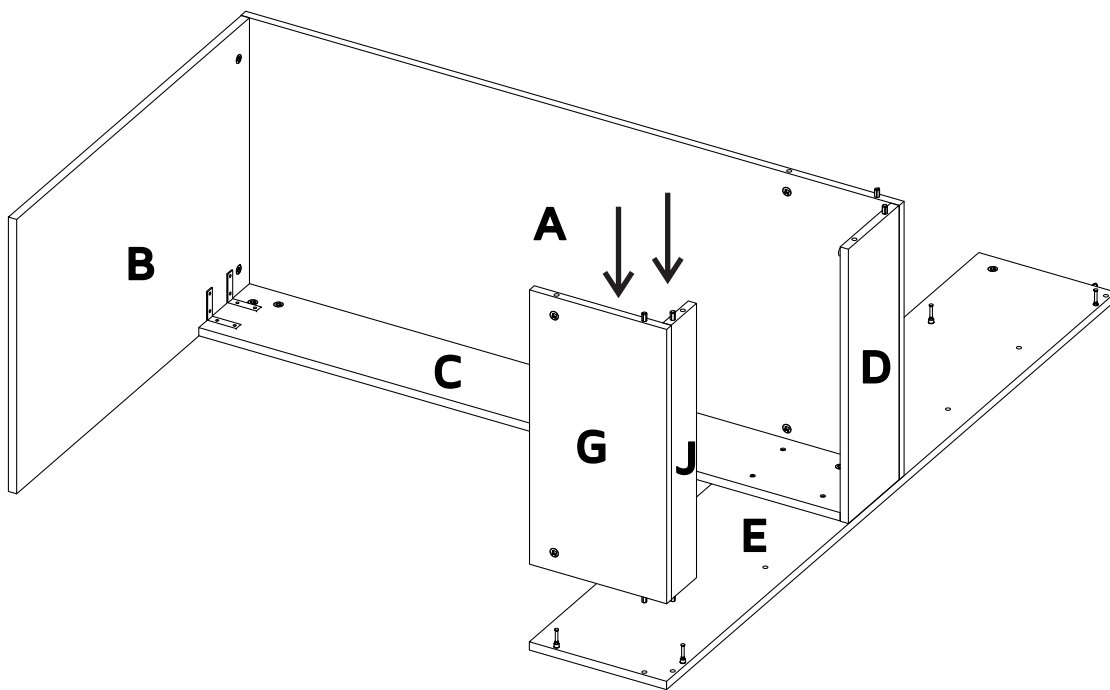

14

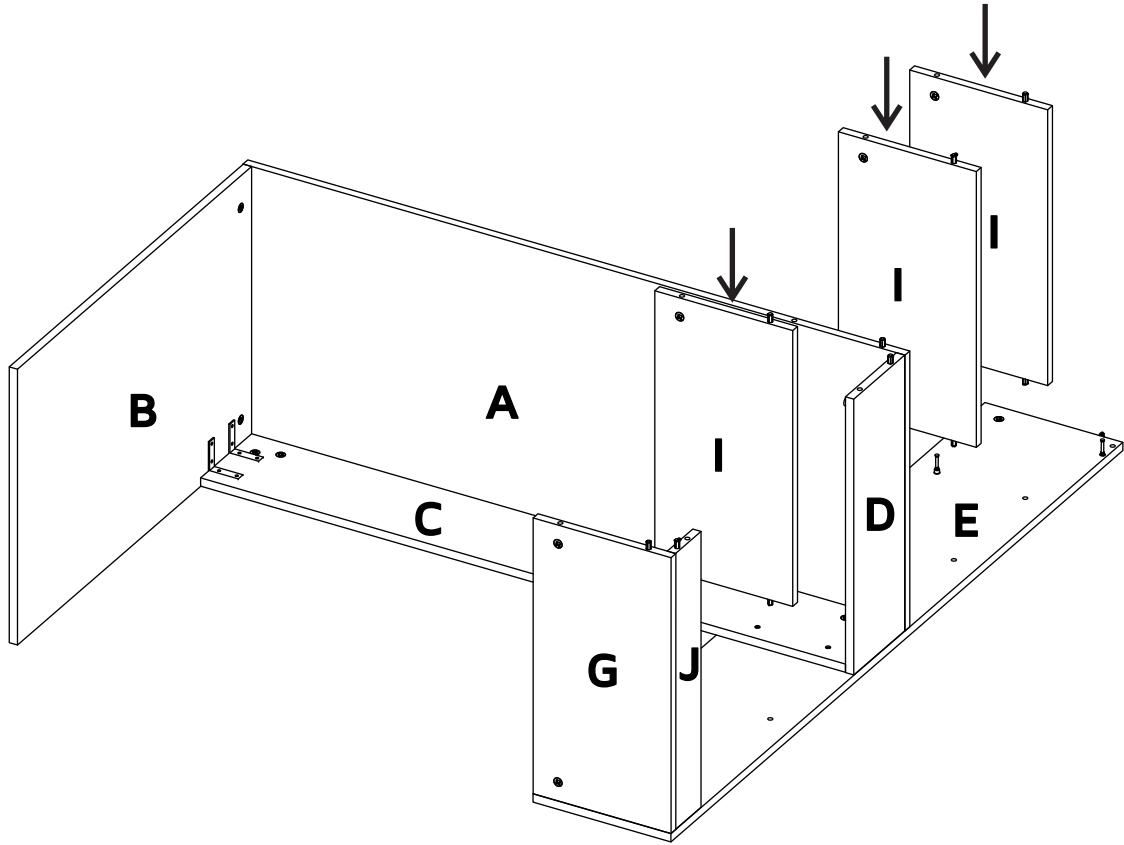

15

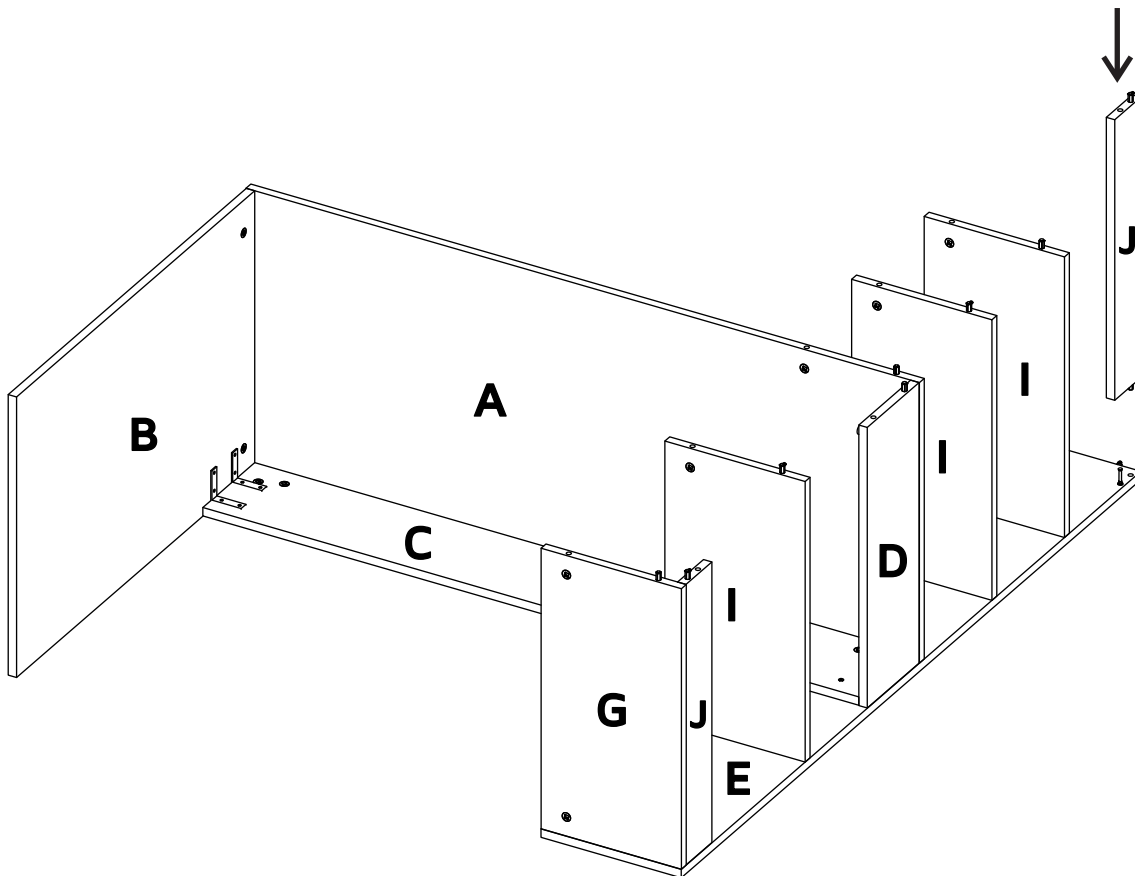

16

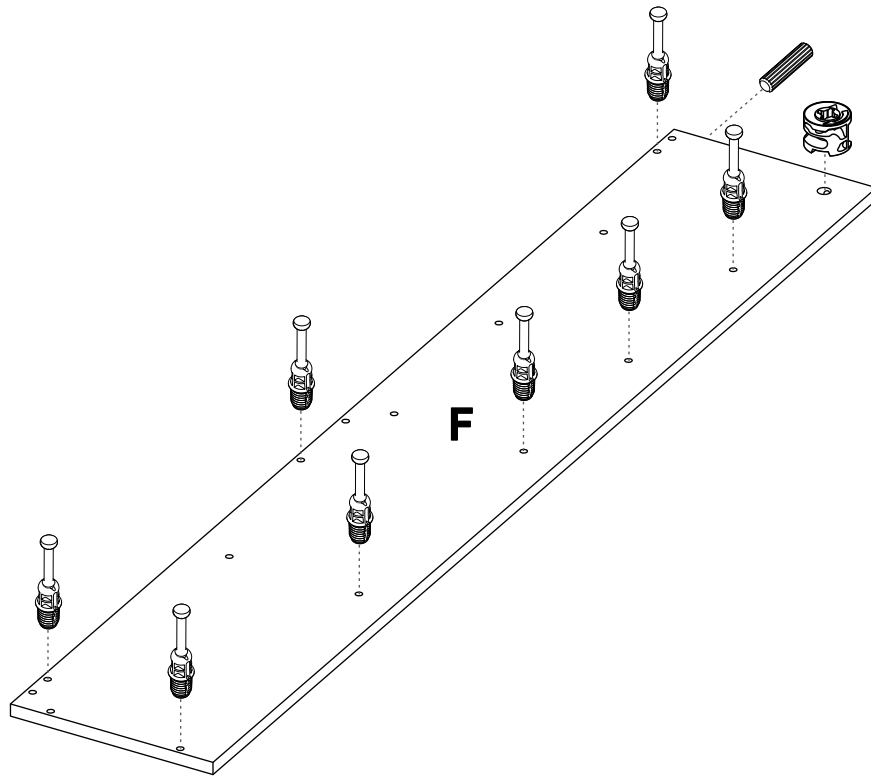

17

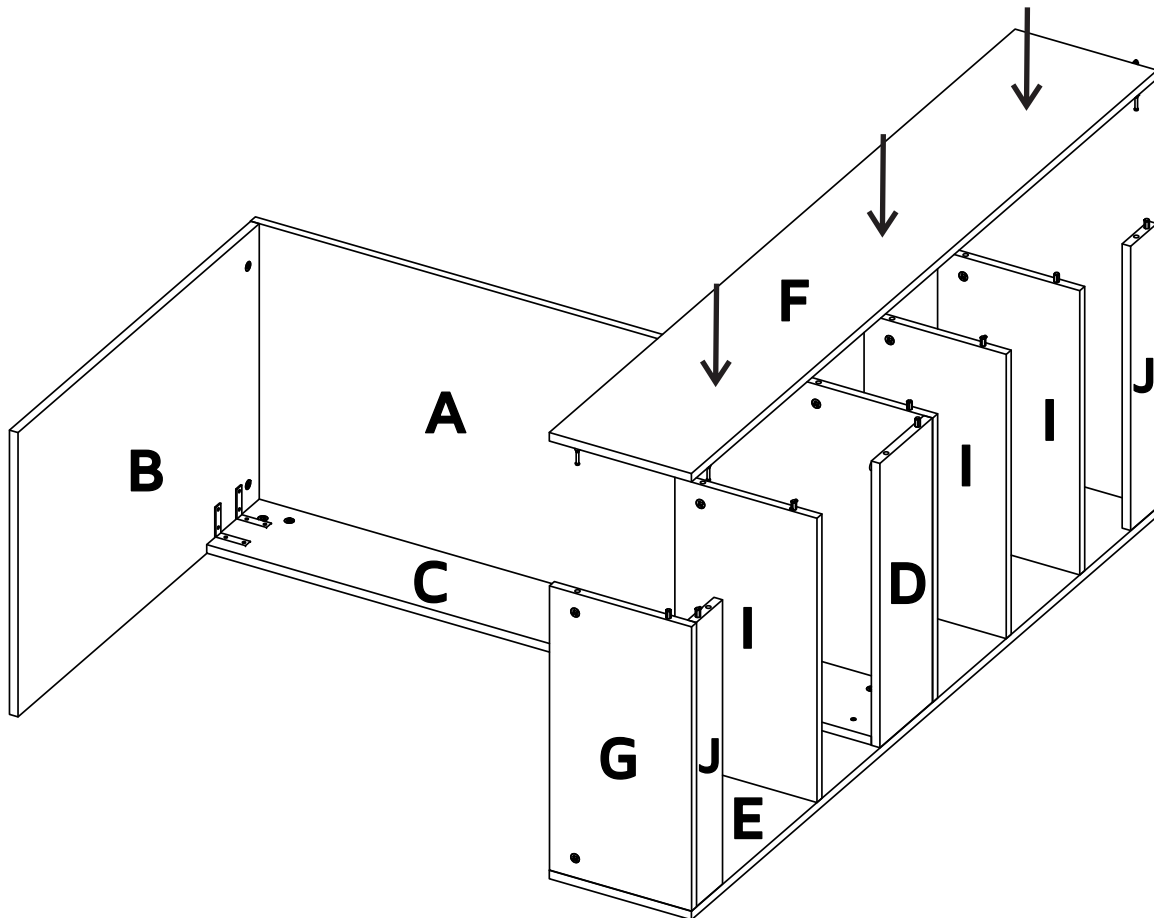

18

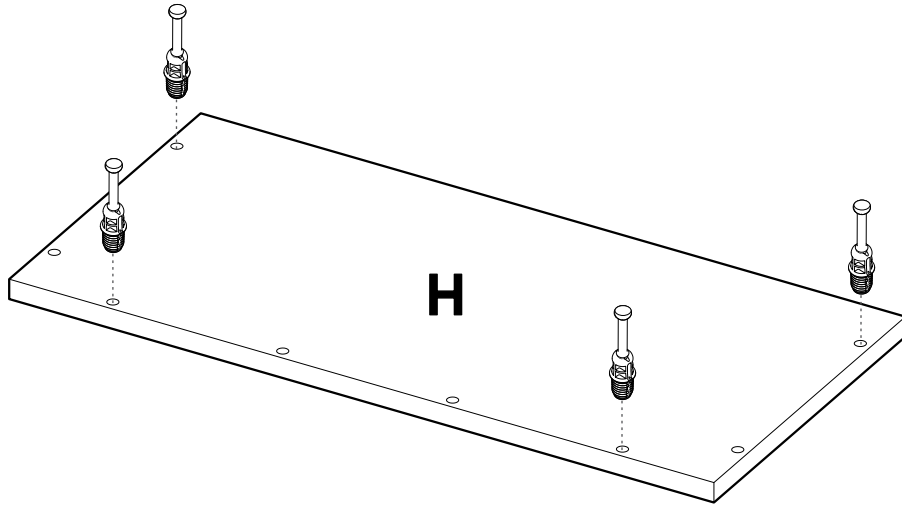

19

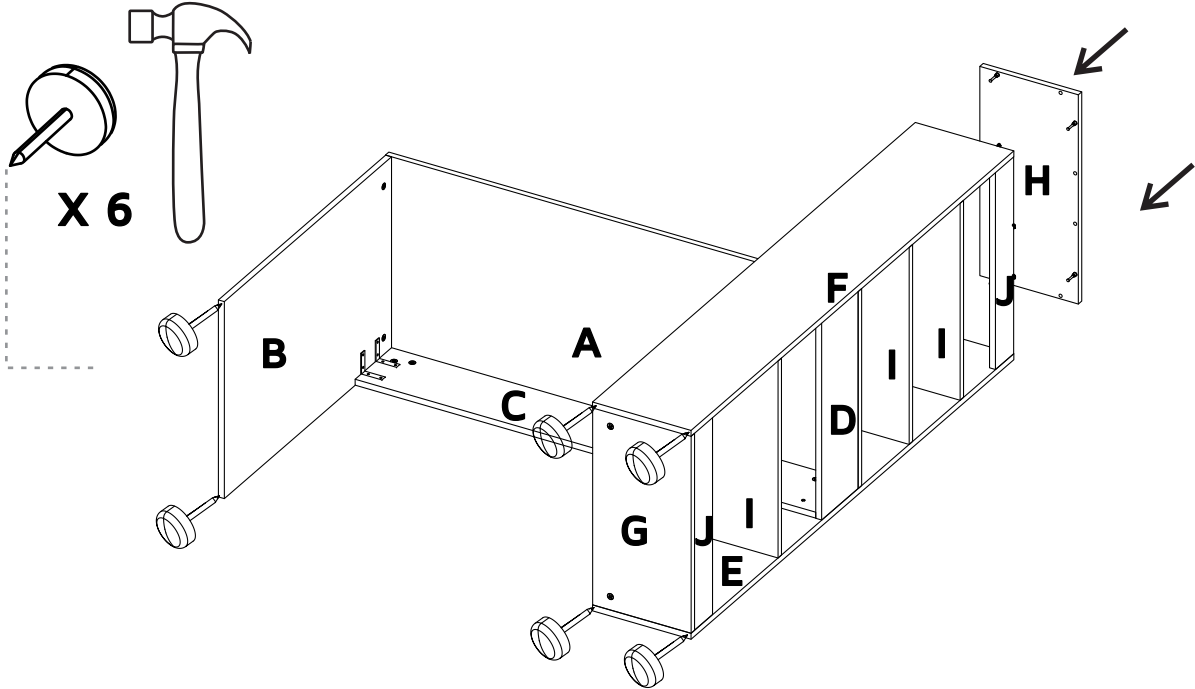

20

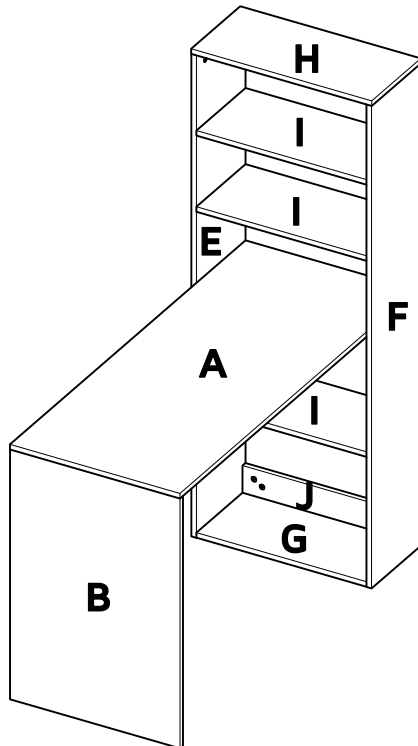

Voltea el mueble

¡Con mucho cuidado!

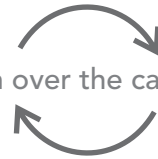

Turn over the cabinet

Very carefully!

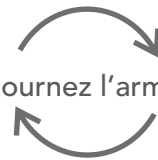

Retournez l'armoire

Très soigneusement!



OBLIGATORIO FIJAR A LA PARED



Utilice los tornillos y chazos adecuados para su muro!

Existe una gran diversidad de muros y paredes, por esta razón no podemos proporcionarle el herraje adecuado para su pared. Primero, es necesario identificar el tipo de pared para luego utilizar el herraje adecuado. En caso de duda, diríjase a una tienda especializada para más información.



OBLIGATORY FIX ON THE WALL



Use screws and plugs suitable for yours wall!

Due to the wide diversity of wall or partition types, we cannot provide you with suitable attachment fixtures. To determine which attachment fixtures to use, you will need to identify the type of wall to which you will be fixing this product. If you have whatever doubt, please, go to one specialised shop for further information.



FIXATION MURALE OBLIGATORIE



Utilisez des vis et des chevilles adaptés a vos murs!

Il existe une grande diversité de types de murs ou cloisons, c'est la raison pour laquelle nous ne pouvons vous fournir un outillage adapté à chaque mur. Tout d'abord, il est nécessaire d'identifier le type de mur sur laquelle sera fixé ce produit afin de se procurer les fixations appropriées. En cas de besoin, pour toute information complémentaire, s'adresser à un magasin spécialisé.

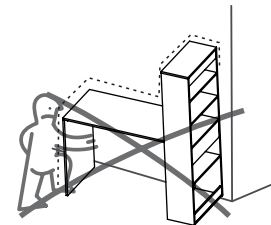
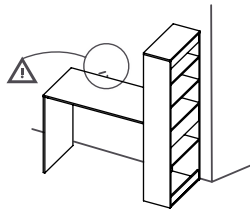

21

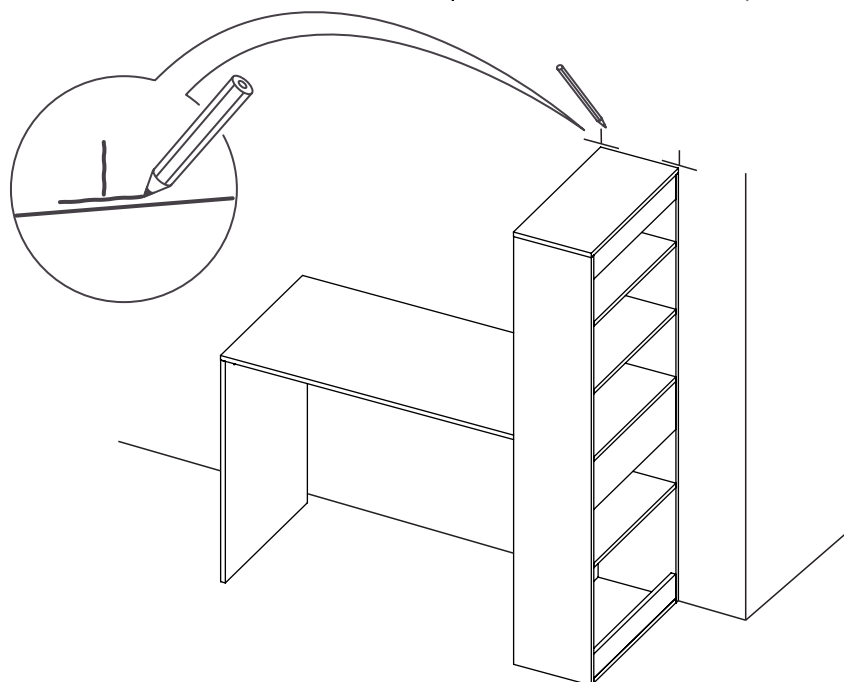

Spanish

IMPORTANTE: Para evitar el vuelco accidental de los muebles, es obligatorio fijarlos en la pared. El tipo de tornillos necesarios para fijar el mueble a la pared, depende del material de la pared, no se suministran. En caso de duda, consulte a un especialista.

English

IMPORTANT: To avoid the accidental tip-over of the furniture, the fixing of the furniture on the wall is mandatory.
The needed hardware for the junction wall/furniture, depending of the nature of the wall, is not provided. If any doubt, consult a specialist.

French

IMPORTANT: Pour éviter le basculement accidentel du meuble, la fixation du meuble au mur est obligatoire.
La visserie nécessaire pour la jonction mur/meuble, dépendante de la nature du mur, n'est pas fournie. En cas de doute, consulter un spécialiste.

Portugese

IMPORTANTE: Para evitar a queda accidental del móveis, é obrigatorio fixá-los na parede. O tipo de parafusos para a fixação de mobiliário na parede, depende do material de parede e não são fornecidos. Em caso de dúvida, consulte um especialista.

Italian

IMPORTANTE: Per evitare il ribaltamento accidentale del mobile é obbligatorio il fissaggio a muro.
I tasselli necessari per il collegamento mobile/muro, dipendenti dal tipo di muro, non sono provvisti. Consultare uno specialista in caso di dubbi.

Croatian

Važno: Kako bi se izbjeglo slučajno prevrtanje, namještaj je potrebno pričvrstiti na (uza) zid. Različite vrste zidova zahtijevau upotrebu različitih vrsta vijaka i tipli. Uvijek koristiti one koji su prikladni za vrstu zidova u domu. Vijci i tiple prodaju se zasebno. U slučaju bilo kakvih sumnji, obratite se stručnjaku.

German



WICHTIG: Um ein versehentliches Kippen des Möbels zu vermeiden, ist die Befestigung an der Wand zwingend vorgeschrieben.
Die benötigten Schrauben zur Wandbefestigung, welche von der Beschaffenheit der Mauer abhängen, sind nicht in der Lieferung enthalten. Wenden Sie sich bitte bei Zweifel and einen Spezialisten.



Debido a la amplia diversidad de tipos de paredes o divisiones, no podemos proporcionarle accesorios de fijación adecuados. Para determinar qué accesorios de fijación utilizar, deberá identificar el tipo de pared a la que fijará este producto. A continuación se muestran algunos ejemplos de accesorios de fijación recomendados para:

MUROS DE MAMPOSTERIA

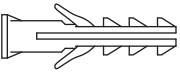
MUROS DE CONSTRUCCIÓN LIVIANA.

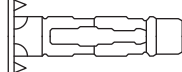
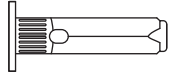
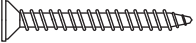
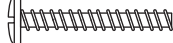
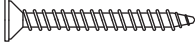
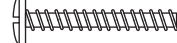
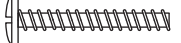
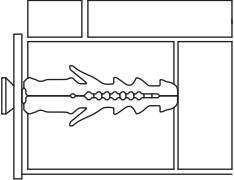
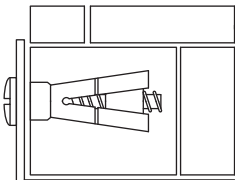
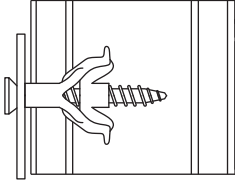
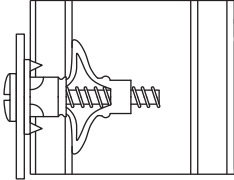
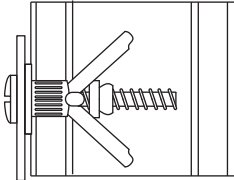
Taco de Nylon Tipo "Fischer"	Taco metalico	Taco de Nylon Tipo arpón	Taco metálico tipo ancla	Taco metalico Tipo "MOLLY"
				
				
				







Utilice una broca que sea compatible en tamaño con el hardware utilizado y el tipo de pared.

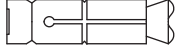

Due to the wide diversity of wall or partition types, we cannot provide you with suitable attachment fixtures- To determine wich attachment fixtures to use, you will need to identify the type of wall to which you will be fixing this product. Here are some examples of attachment fixtures recommended for:

BLIND WALLS

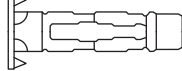
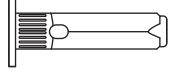
STUDED WALL

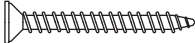
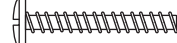
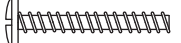
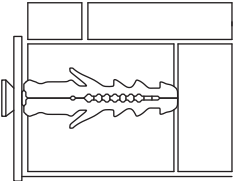
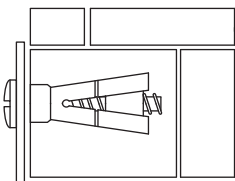
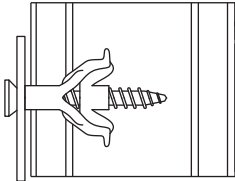
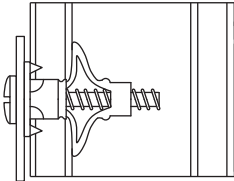
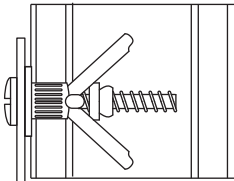
"Fischer" Nylon plug	Metal Wall plug	Nylon winged Wall plug	Metal expansion plug	"MOLLY" PLUG
				
				
				



Use a drill bit that is compatible in size with the hardware used and the type of wall.



Il existe une grande diversité de types de murs ou cloisons, c'est la raison pour laquelle nous ne pouvons pas vous fournir le type exact de fixation adapté au vôtre. Il est nécessaire d'identifier le type de mur sur lequel vous allez fixer ce produit, afin de vous procurer les fixations appropriées. Voici quelques exemples de fixations recommandées pour :

LES MURS EN MAÇONNERIE

LES CLOISONS CREUSES

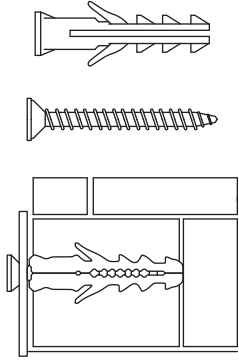
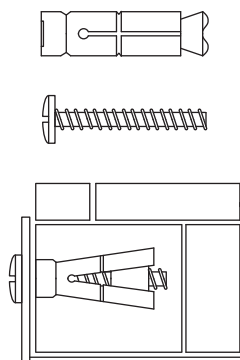
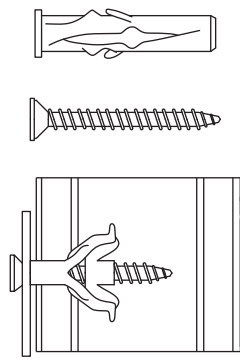
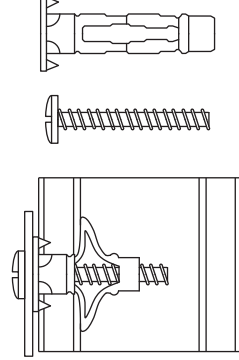
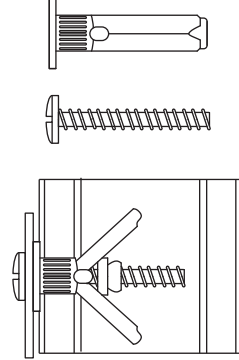
Cheville nylon "Fischer"	Cheville d'ancrage métal	Cheville d'ancrage à ailettes en nylon	Cheville métallique à expansion	Cheville "MOLLY"
				



Utiliser une taille de foret adaptée à la quincaillerie utilisée et au type de mur.

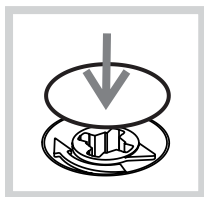
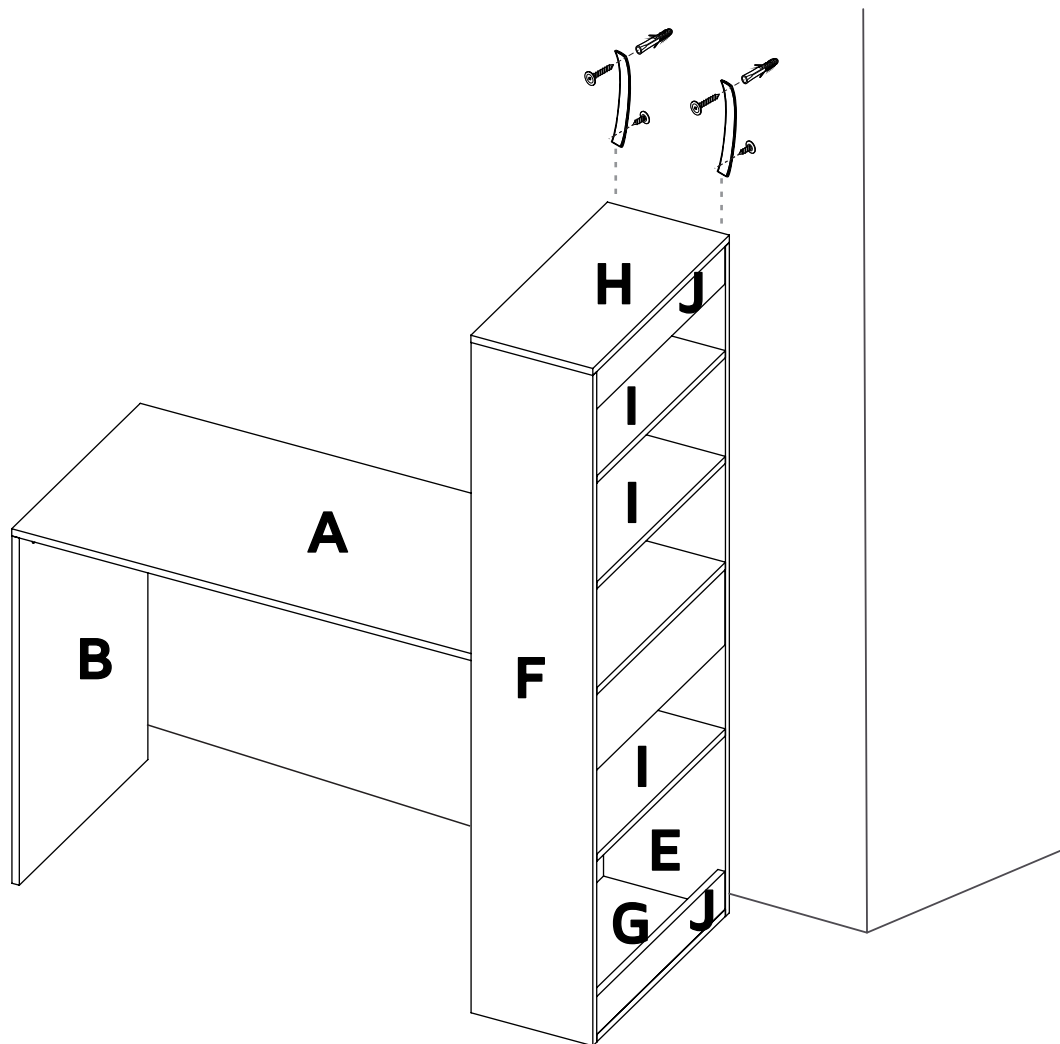

Después de ajustar todas las cajas minifix, cúbreelas con las tapas adhesivas.

After you finish the adjustment of the cams, cover them with the cover caps.
Après avoir terminé le réglage des cames, les couvrir avec les caches.

A

Cuando termines de armar, desprende los adhesivos de las letras en cada pieza

After you finish assembling the cabinet, take off the adhesive letters.
Une fois le montage de l'armoire terminé, retirer les lettres adhésives.

Derechos legales generales

En virtud de la normativa vigente en materia de consumidores, el cliente goza de una garantía legal, respondiendo TUHOME a la falta de conformidad de sus productos en dicho plazo, a contar desde la entrega del artículo.

Condiciones de la garantía

Para que esta garantía sea válida, debe escribir a nuestro correo electrónico de servicio al cliente describiendo el defecto del producto, el número de lote y la presentación de la factura o prueba de compra del producto; o puede contactarse telefónicamente con nuestra línea de servicio al cliente. Las piezas reemplazadas estarán bajo el periodo de cobertura de garantía original del producto. Las piezas dañadas pasarán a hacer propiedad de la empresa.

Los muebles de TUHOME cuentan con un periodo de cobertura de garantía de 3 años en partes de madera y una cobertura de garantía de 1 año en partes de ferretería desde su fecha de entrega, la cual se puede ver en el número de lote impreso en la caja del producto y en el instructivo de armado.

En caso de no conformidad con el artículo adquirido, este dispone de devolución siempre y cuando se haga dentro de los 14 días siguientes a su recepción en el domicilio.

¿Qué cubre esta garantía?

La garantía cubre defectos en materiales y mano de obra que impiden el correcto armado y funcionamiento del mueble.

¿Qué no cubre esta garantía?

Esta garantía no es válida si los defectos o imperfecciones son causadas por el incorrecto seguimiento de las instrucciones de armado, advertencias y recomendaciones, mal uso, daño intencional, fuego e inundaciones, o luego de modificaciones o alteraciones del producto de cualquier tipo, o reparaciones realizadas por personas no autorizadas por DEPOT ESPAÑA después de 3 meses luego de haber sido armado el producto. Estos defectos DEBEN ser reportados antes de la finalización del periodo de cobertura de la garantía. Una vez el producto haya sido armado, la empresa no se hace responsable por piezas defectuosas o que hayan sido dañadas.

Esta garantía es válida SOLO para el COMPRADOR ORIGINAL, no aplica si el producto ha sido alquilado o revendido.

TUHOME no asumirá ninguna responsabilidad por daños incidentales o consecuentes causados a o por el producto.

No hay otras garantías aplicables a este producto

General legal rights

Under current consumer regulations, customers have a legal guarantee. TUHOME will respond to any product non-conformity within the guarantee period, which begins when the item is delivered.

Guarantee conditions

To make this warranty valid you must write to our customer service email describing the product defect, lot number and submitting your sales receipt or proof of purchase, or contact us at our customer service line. Replaced parts will be under the product's original warranty coverage period. Damaged parts will become property of the company.

TUHOME Furniture has a 3-year warranty coverage in wooden parts and 1 year warranty coverage in hardware pieces since its delivering date, which you can see in the lot number printed on the product box and the assembly instructions leaflet.

In case of non-conformity with the purchased item, it can be returned as long as it is made within 14 days of its receipt at home.

What does this guarantee cover?

Warranty covers materials and workmanship imperfections which impair the assembly or correct functioning of the cabinet.

What does this guarantee not cover?

This warranty is not valid if the defects or imperfections are caused by the incorrect following of the assembly instructions, warnings and recommendations, misuse, intentional damage, fire or flood, or after modifications or any kind of alteration, or repaired by someone not authorized by TUHOME, when it's been assembled 3 months after the date of purchase. These defects **MUST** be reported before the warranty coverage period ends. Once the product has been assembled, the company will not be responsible for defective and/or damaged parts.

This warranty is **ONLY** valid for the **ORIGINAL PURCHASER**, it doesn't apply if the product has been resold or rented.

TUHOME will take no liability for incidental or consequential damages caused to or by the product.

There are no other warranties applicable to this product.

Droits légaux généraux

En vertu de la réglementation en vigueur en matière de consommateurs, le client bénéficie d'une garantie légale, TUHOME répondant à la non-conformité de ses produits dans ce délai, à compter de la livraison de l'article.

Conditions de la garantie

Pour que cette garantie soit valide, vous devez écrire à notre courriel de service clientèle décrivant le défaut du produit, le numéro de lot et la présentation de la facture ou de la preuve d'achat du produit ; vous pouvez aussi contacter par téléphone notre ligne de service clientèle. Les pièces remplacées seront soumises à la période de garantie initiale du produit. Les pièces endommagées deviendront la propriété de l'entreprise.

Les meubles TUHOME bénéficient d'une période de garantie de 3 ans sur les pièces en bois et d'une couverture de garantie d'un an sur les pièces de quincaillerie à partir de leur date de livraison, qui apparaît dans le numéro de lot imprimé sur la boîte du produit et dans les instructions de montage.

En cas de non-conformité de l'article acheté, celui-ci peut être retourné à condition que le retour soit effectué dans les 14 jours suivant sa réception au domicile..

Que couvre cette garantie ?

La garantie couvre les défauts de matériaux et de main-d'œuvre qui empêchent le bon assemblage et le bon fonctionnement du meuble.

Qu'est-ce qui n'est pas couvert par cette garantie ?

Cette garantie n'est pas valable si les défauts ou imperfections sont causés par un mauvais suivi des instructions de montage, des avertissements et des recommandations, par une mauvaise utilisation, par des dommages intentionnels, par des incendies et des inondations, ou par des modifications ou des altérations du produit de quelque nature que ce soit, ou encore par des réparations effectuées par des personnes non autorisées par DEPOT ESPAÑA /DÉPÔT ESPAGNE plus de 3 mois après le montage du produit. Ces défauts DOIVENT être signalés avant la fin de la période de couverture de la garantie. Une fois le produit assemblé, l'entreprise n'est pas responsable des pièces défectueuses ou endommagées.

Cette garantie est valable SEULEMENT pour l'ACHETEUR ORIGINAL, elle ne s'applique pas si le produit a été loué ou revendu.

TUHOME n'assume aucune responsabilité quant aux dommages accessoires ou conséquents causés sur le produit ou par celui-ci.

Aucune autre garantie ne s'applique à ce produit.