

# R-630

## Manual de Montagem

Assembly Manual / Manual de Armado

Rev.: 01

Data: 07/03/2024

Cód.:

### Rack 2 Portas Rack 2 Puertas Rack 2 Doors

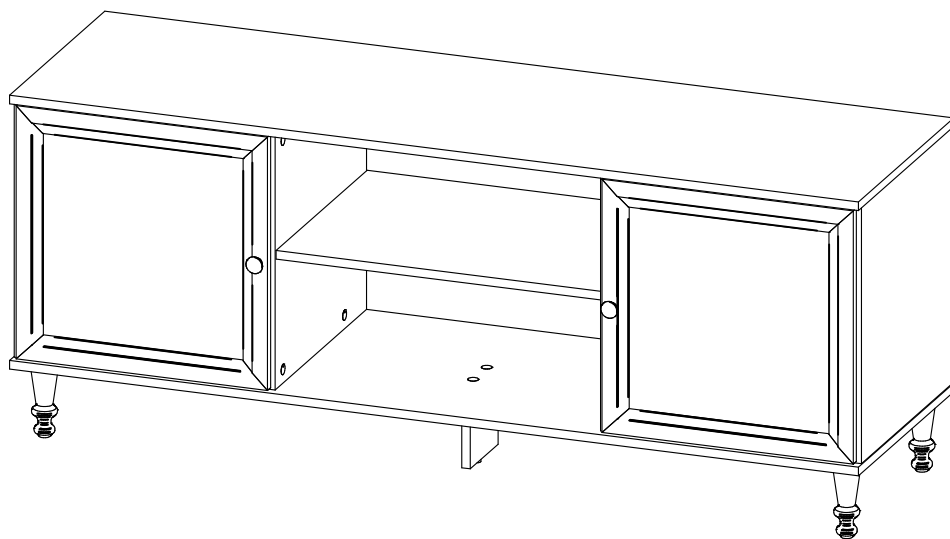

#### Notas especiais:

- 01 - Examine completamente todas as peças do móvel antes de iniciar o trabalho.
- 02 - Recomenda-se montar o móvel conforme este manual de montagem.
- 03 - É de responsabilidade do montador seguir as instruções do Manual de Montagem, que são fundamentais para garantir a estrutura do móvel.

#### Special Notes:

- 01 - Examine carefully all parts of the furniture before starting the work.
- 02 - It is recommended to assemble the furniture as explained in this assembly manual.
- 03 - The assembler has the responsibility of following the instructions of the Assembly Manual, which are essential to insure the furniture structure.

#### Notas Especiales:

- 01 - Examinar en detalle todas las piezas del mueble antes de comenzar el armado.
- 02 - Se recomienda montar el mueble utilizando este manual de armado. En caso de duda póngase en contacto con el Servicio al cliente de Easy.
- 03 - Es responsabilidad del instalador de seguir las instrucciones del manual de Armado, que son esenciales para asegurar la estructura y resistencia del mueble.

#### Aviso:

Para mais informações consulte as notas especiais, através do link: [www.ditalia.com.br](http://www.ditalia.com.br)  
For further information please check the special notes accessing the link: [www.ditalia.com.br](http://www.ditalia.com.br)

Para más informaciones favor dirigirse a los apuntes especiales a través del link: [www.ditalia.com.br](http://www.ditalia.com.br)















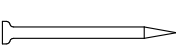
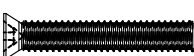

**Antes de montar seu móvel, leia cuidadosamente o Manual de Instruções e o mantenha para futuras consultas. OBRIGADO. Before assembling your furniture, read the Assembly Instructions carefully, and keep it for future checking. THANKS! Antes de armar su mueble, lea el Manual de Instrucciones cuidadosamente y consérvelo para futuras referencias. GRACIAS**

Ditalia Móveis Industrial Ltda • Estrada RS-444, s/n • KM-26 • Prédio Adm. • Monte Belo do Sul • RS • Brasil  
• CEP-95718-000 • Fone/Fax (55.54) 2102.5000 • e-mail: [assistencia@ditalia.com.br](mailto:assistencia@ditalia.com.br) • [www.ditalia.com.br](http://www.ditalia.com.br)



**Limpeza:** utilizar apenas pano umedecido com água.  
**Cleaning:** use only a cloth moistened with water.  
**Limpieza:** use sólo un paño humedecido en agua.

**LISTA DE FERRAGENS / HARDWARE LIST / LISTA DE MATERIALES**

COD	DESCRIÇÃO / DESCRIPTION / DESCRIPCIÓN	QTD
<b>A</b>	 Cavilha Ø6x30 Wood Dowel / Clavija	<b>16</b>
<b>AZ</b>	 Chave 21x47x4 Key 21x47x4 / Clave 21x47x4	<b>1</b>
<b>B</b>	 Parafuso Minifix Minifix screw / Tornillo minifix	<b>16</b>
<b>BO</b>	 Fixador Costa Back Fixation / Fijador Costa	<b>8</b>
<b>C</b>	 Tambor Minifix Drum Lock / Tambor Minifix	<b>16</b>
<b>D</b>	 Parafuso CC 3,5x14 Screw / Tornillo	<b>16</b>
<b>DB</b>	 Dobradiça Baixa Hinge / Bisagra	<b>4</b>
<b>DZ</b>	 Parafuso CC 7x50 Screw / Tornillo	<b>6</b>
<b>EN</b>	 Prego 10x10 Tack / Clavo	<b>50</b>
<b>FB</b>	 Parafuso M4x20 Screw / Tornillo	<b>2</b>
<b>FM</b>	 Tampa para parafuso Allen Screw Cap / Tapa p/ Tornillo	<b>4</b>
<b>GD</b>	 Suporte Prateleira Plastic Pin / Suporte Estante	<b>12</b>
<b>PE</b>	 Pé Madeira Foot / Pie	<b>4</b>
<b>PF</b>	 Perfil H H Profile / Perfil H	<b>1</b>
<b>PX</b>	 Puxador Ø 29,5 Handle / Manija	<b>2</b>
<b>X</b>	 Sapata Deslizadora Small plastic foot / Pie plástico	<b>1</b>
<b>Y</b>	 Adesivo Tapa Furo Sticker / Adesivo	<b>18</b>

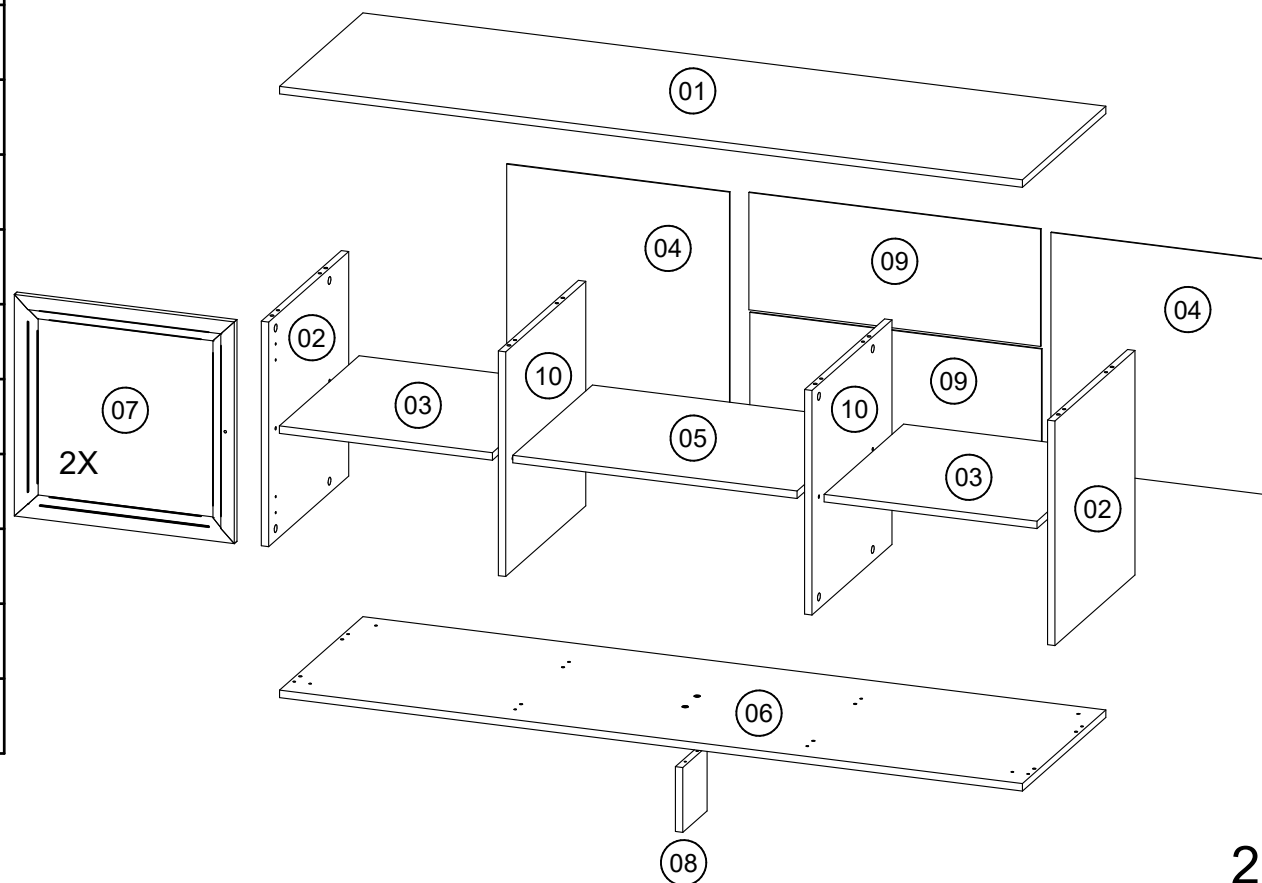

**LISTA DE PEÇAS/PIECES LIST/LISTA DE PIEZAS**

Nº	COD __ DESCRIÇÃO/DESCRIPTION/DESCRIPCIÓN	DIMENSÃO/DIM	QTD
01	102356 Tampo / Top / Tapa	1500 x 446 x 15	1
02	102357 Lateral / Side / Lateral	450 x 428 x 15	2
03	102360 Prateleira Menor / Shelf / Estante	430 x 426 x 15	2
04	102358 Costa / Back / Costa	450 x 471 x 3	2
05	102362 Prateleira / Shelf / Estante	574 x 426 x 15	1
06	102359 Base / Base / Base	1500 x 446 x 15	1
07	102369 Porta Moldura / Door / Puerta	444 x 444 x 15	2
08	102363 Pé Central / Foot / Pie	130 x 130 x 15	1
09	102364 Costa Central / Back / Costa	589 x 235 x 3	2
10	102361 Divisão / Division / División	450 x 428 x 15	2



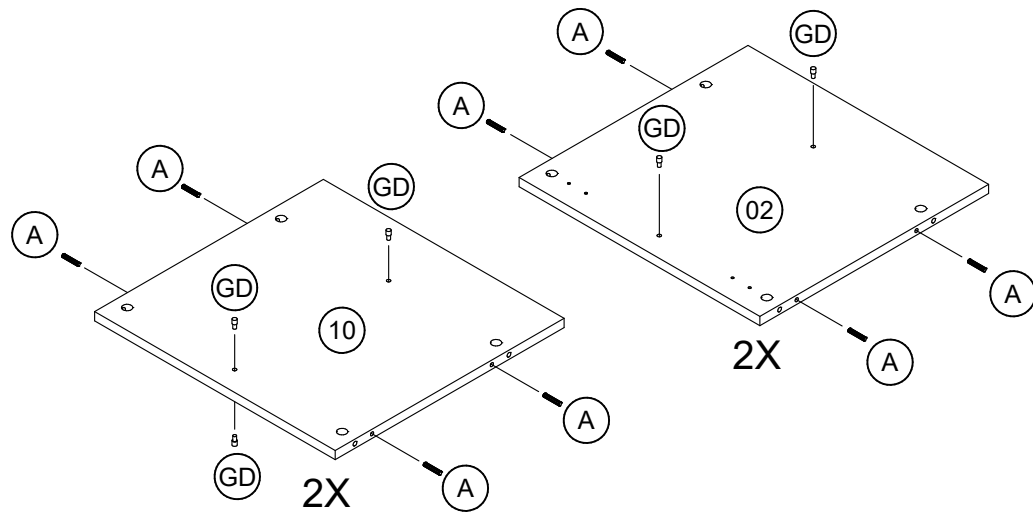

01

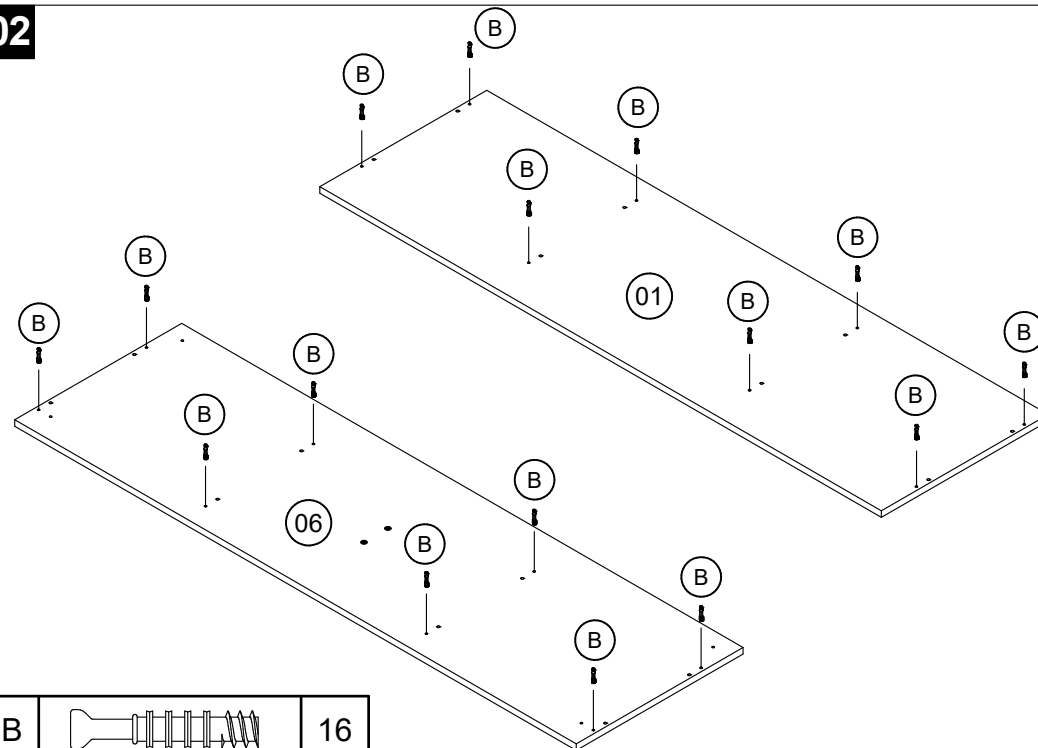

A		16
GD		12

02





B		16
---	---	----

03

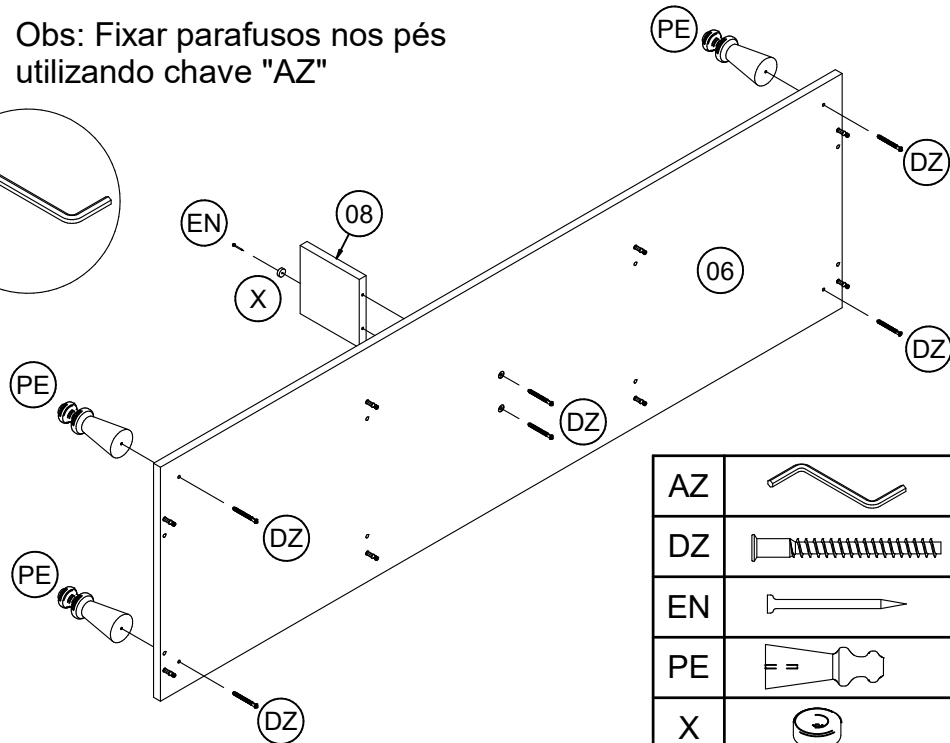
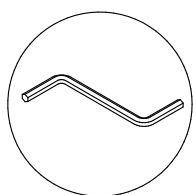
Obs: Fixar parafusos nos pés utilizando chave "AZ"

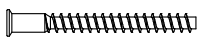
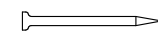

AZ		1
DZ		6
EN		1
PE		4
X		1

04

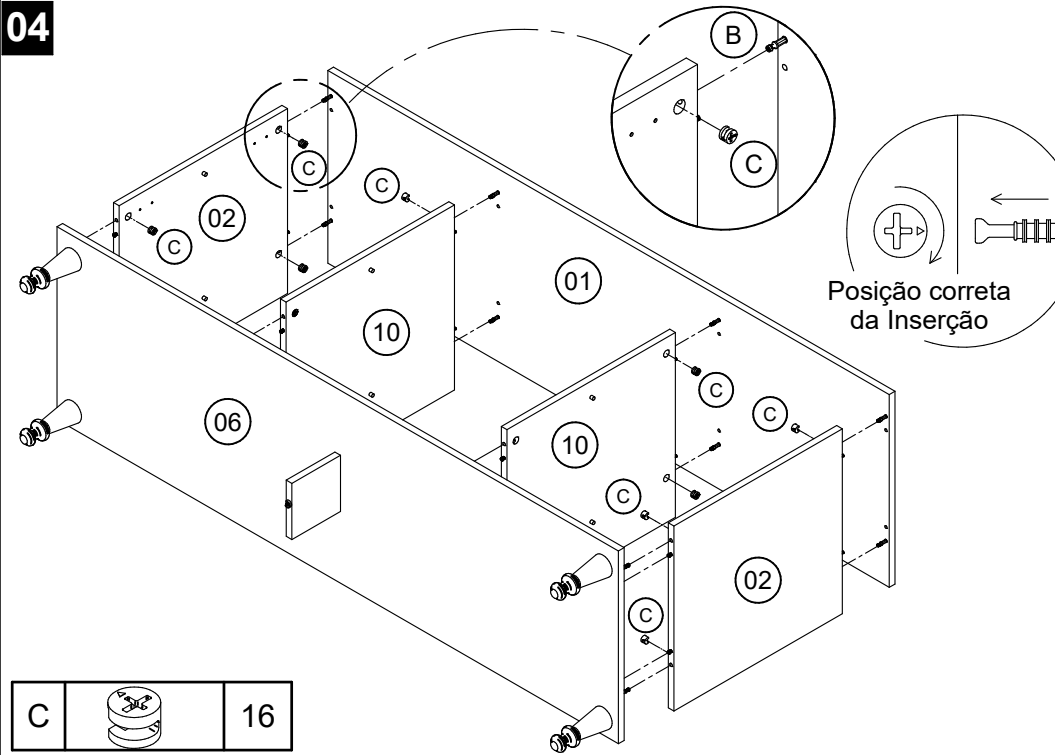

Posição correta da Inserção

C		16
---	---	----

05

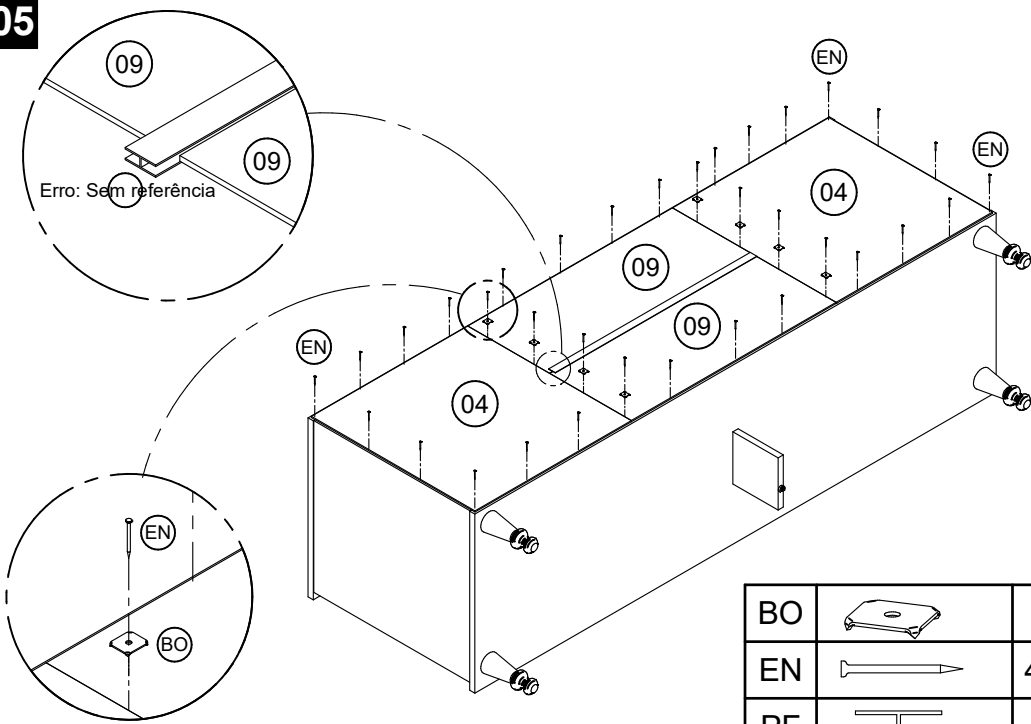

06

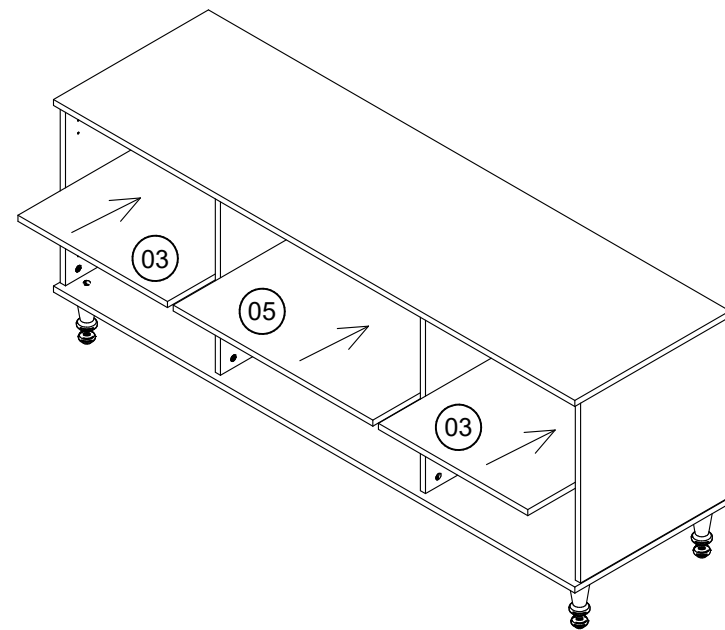

07

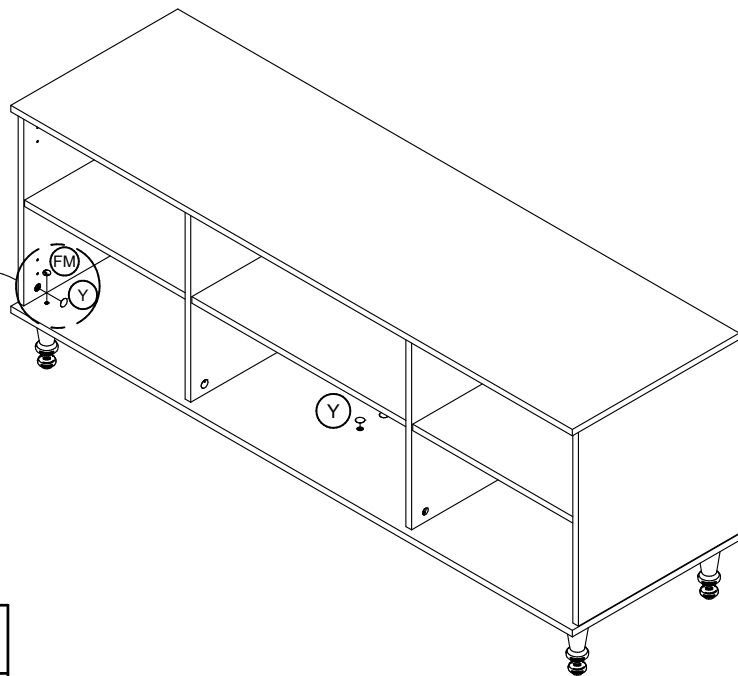

FM		4
Y		18

08

