



**JCM**  
movelaria

# Livreiro Giga Giga Bookshelf Estantería Giga



Indicamos que a montagem dos produtos seja realizada com parafusadeira eléctrica e por um montador profissional.  
**We recommend that a professional furniture assembler assemble the product by using a cordless screwdriver.**  
*Se recomienda que un montador de muebles profesional realice el montaje del producto con un destornillador eléctrico.*

AVISO: Não nos comprometemos pelo mal-uso, montagem e fixação do produto à parede. Portanto, não somos responsáveis por danos e quedas do produto, eletrônicos e pertences neles contidos. É importante o uso de brocas e ferramentas compatíveis na montagem.  
NOTICE: The company is not responsible for the misuse, assembly, and wall fixation, as well as the damages and falls that the products, electronics, and belongings therein might suffer. It is important to use suitable drills and tools to assemble the product.  
ATENCIÓN: La empresa no se responsabiliza del mal uso, montaje y fijación del producto a la pared, así como de daños y caídas del producto, electrónicos u objetos. Es importante el uso de taladros y herramientas compatibles con el montaje.

Dica: para evitar possíveis avarias, use a embalagem do produto como apoio durante a montagem.  
**Tip: to avoid damages, use the product packaging as a base during the assembly.**  
*Pista: para evitar daños, use el envase del producto como apoyo durante el montaje.*

## RELAÇÃO DE FERRAGENS | HARDWARE LIST | LISTADO DE HERRAJES

CAVILHA 6x30	(A)	<b>6x30 DOWEL</b>	(A)	CLAVIJA 6x30	(A)		22
CONEXÃO ANGULAR	(B)	<b>CORNER JOINT</b>	(B)	SOPORTE ANGULAR	(B)		02
PARAFUSO 4,0x20	(C)	<b>4x20 SCREW</b>	(C)	TORNILLO 4x20	(C)		16
PARAFUSO 3,5x14 FLANGEADO	(D)	<b>3.5x14 FLANGE SCREW</b>	(D)	TORNILLO FLANGE 3,5x14	(D)		32
PARAFUSO 5x40	(E)	<b>5x40 SCREW</b>	(E)	TORNILLO 5x40	(E)		34
PARAFUSO 3/16x25	(F)	<b>3/16x25 SCREW</b>	(F)	TORNILLO 3/16x25	(F)		01
PORCA 3/16	(G)	<b>3/16 NUT</b>	(G)	TUERCA 3/16	(G)		01
PREGO 8x8 C/C	(H)	<b>8x8 NAIL</b>	(H)	CLAVO 8x8	(H)		20
PUXADOR COURO 120mm	(I)	<b>SYNTHETIC LEATHER HANDLE</b>	(I)	TIRADOR DE CUERO SINTÉTICO	(I)		01

RELAÇÃO DE PEÇAS | PARTS LIST | LISTADO DE PARTES

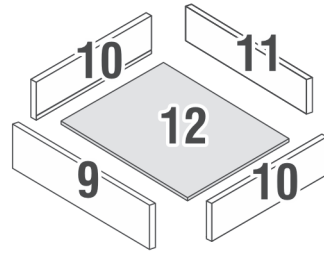
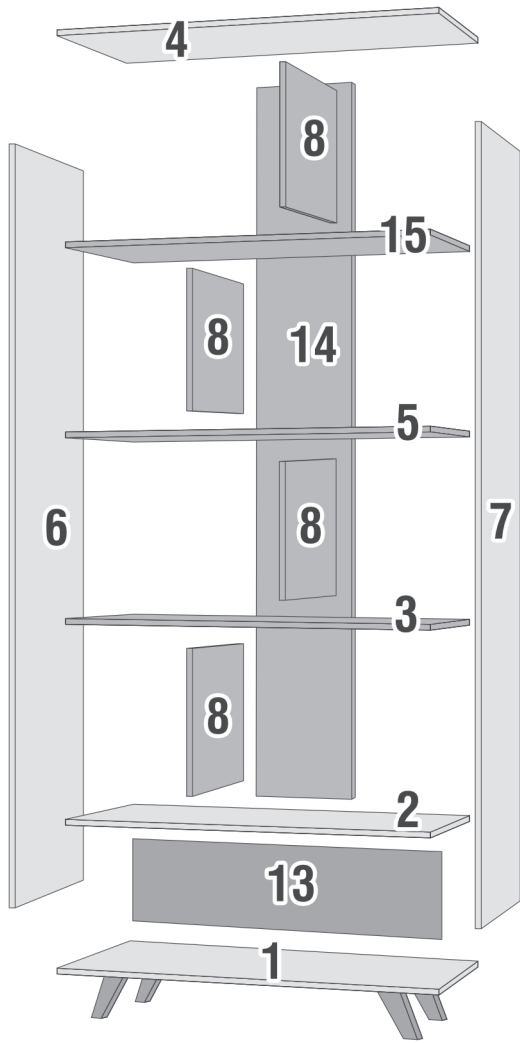

**1** Base  
Bottom Base  
1Pc

**2** Prateleira Gaveta  
Drawer Top  
Tapa del Cajón  
1Pc

**3** Prateleira Inferior  
Bottom Shelf  
Estante Inferior  
1Pc

**4** Tampo Superior  
Top  
Tapa  
1Pc

**5** Prateleira Central  
Middle Shelf  
Estante Central  
1Pc

**6** Lateral Esquerda  
Left Side  
Lateral Izquierdo  
1Pc

**7** Lateral Direita  
Right Side  
Lateral Derecho  
1Pc

**8** Divisão  
Shelf Divider  
División de Estante  
4Pcs

**9** Frente Gaveta  
Drawer Front  
Frente del Cajón  
1Pc

**10** Lateral Gaveta  
Drawer Side  
Lateral del Cajón  
2Pcs

**11** Traseiro Gaveta  
Drawer Back  
Trasera del Cajón  
1Pc

**12** Fundo Gaveta  
Drawer Bottom  
Fondo del Cajón  
1Pc

**13** Costas Direita Inferior  
Bottom Back Panel  
Panel Trasero Inferior  
1Pc

**14** Costas Direita Superior  
Top Back Panel  
Panel Trasero Superior  
1Pc

**15** Prateleira Superior  
Top Shelf  
Estante Superior  
1Pc

**Pé**  
Foot  
Pata  
4Pcs

**Passo 01** COMECE A MONTAGEM PELA PEÇA 04. EM SEGUIDA, PARAFUSE AS PEÇAS 06 E 07 NA PEÇA 04 COM PARAFUSO 5x40 (E). ENCAIXE E PARAFUSE A PEÇA 08 NA PEÇA 04 COM CAVILHA 6x30 (A) E PARAFUSO 5x40 (E). ENCAIXE E PARAFUSE A PEÇA 15 NAS PEÇAS 06, 08 E 07 COM CAVILHA 6x30 (A) E PARAFUSO 5x40 (E).

**Step 01** START THE ASSEMBLY FROM PART 4. AFTER THAT, FASTEN PARTS 6 AND 7 TO PART 4 WITH 5x40 SCREWS (E). FASTEN PART 8 TO PART 4 WITH 6x30 DOWELS (A) AND 5x40 SCREWS (E). FASTEN PART 15 TO PARTS 6, 8, AND 7 WITH 6x30 DOWELS (A) AND 5x40 SCREWS (E).

**Paso 01** EMPIECE EL MONTAJE POR LA PARTE 4. A CONTINUACIÓN, FIJE LAS PARTES 6 Y 7 A LA PARTE 4 CON TORNILLOS 5x40 (E). FIJE LA PARTE 8 A LA PARTE 4 CON CLAVIJAS 6x30 (A) Y TORNILLOS 5x40 (E). FIJE LA PARTE 15 A LAS PARTES 6, 8 Y 7 CON CLAVIJAS 6x30 (A) Y TORNILLOS 5x40 (E).

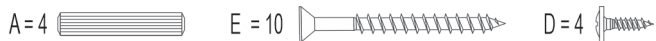
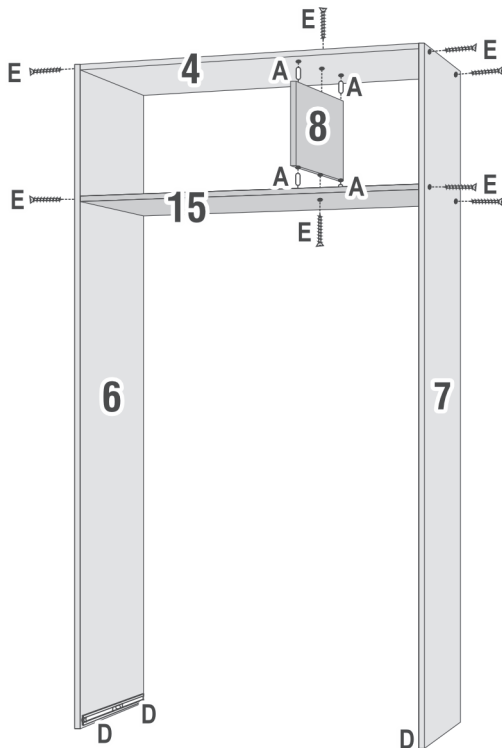

**Passo 02** ENCAIXE E PARAFUSE A PEÇA 08 NA PEÇA 15 COM CAVILHA 6x30 (A) E PARAFUSO 5x40 (E). EM SEGUIDA, ENCAIXE E PARAFUSE A PEÇA 05 NAS PEÇAS 06, 08 E 07 COM CAVILHA 6x30 (A) E PARAFUSO 5x40 (E).

**Step 02** FASTEN PART 8 TO PART 15 WITH 6x30 DOWELS (A) AND 5x40 SCREWS (E). THEN FASTEN PART 5 TO PARTS 6, 8, AND 7 WITH 6x30 DOWELS (A) AND 5x40 SCREWS (E).

**Paso 02** FIJE LA PARTE 8 A LA PARTE 15 CON CLAVIJAS 6x30 (A) Y TORNILLOS 5x40 (E). DESPUÉS FIJE LA PARTE 5 A LAS PARTES 6, 8 Y 7 CON CLAVIJAS 6x30 (A) Y TORNILLOS 5x40 (E).

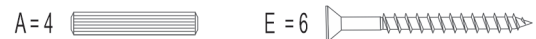
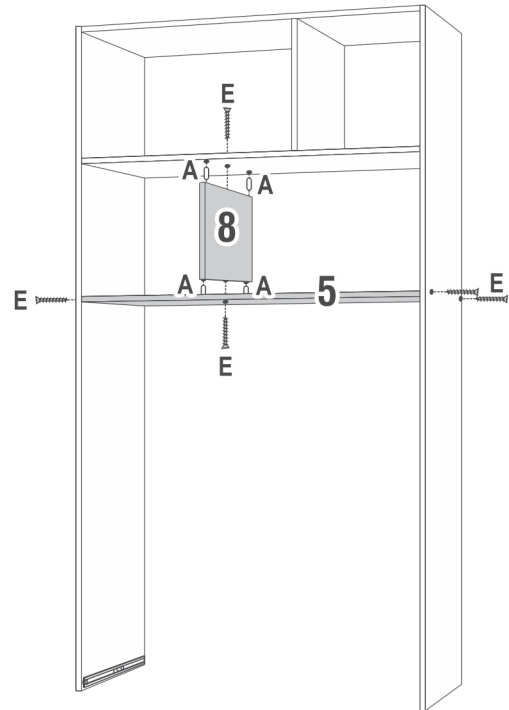

**Passo 03** ENCAIXE E PARAFUSE A PEÇA 08 NA PEÇA 05 COM CAVILHA 6x30 (A) E PARAFUSO 5x40 (E). EM SEGUIDA, ENCAIXE E PARAFUSE A PEÇA 03 NAS PEÇAS 06, 08 E 07 COM CAVILHA 6x30 (A) E PARAFUSO 5x40 (E).

**Step 03** FASTEN PART 8 TO PART 5 WITH 6x30 DOWELS (A) AND 5x40 SCREWS (E). THEN FASTEN PART 3 TO PARTS 6, 8, AND 7 WITH 6x30 DOWELS (A) AND 5x40 SCREWS (E).

**Paso 03** FIJE LA PARTE 8 A LA PARTE 5 CON CLAVIJAS 6x30 (A) Y TORNILLOS 5x40 (E). DESPUÉS FIJE LA PARTE 3 A LAS PARTES 6, 8 Y 7 CON CLAVIJAS 6x30 (A) Y TORNILLOS 5x40 (E).

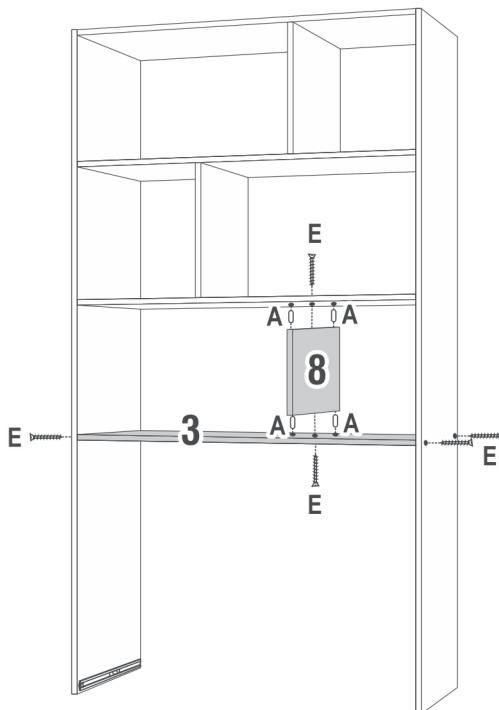

**Passo 04** ENCAIXE E PARAFUSE A PEÇA 08 NA PEÇA 03 COM CAVILHA 6x30 (A) E PARAFUSO 5x40 (E). EM SEGUIDA, ENCAIXE E PARAFUSE A PEÇA 02 NAS PEÇAS 06, 08 E 07 COM CAVILHA 6x30 (A) E PARAFUSO 5x40 (E).

**Step 04** FASTEN PART 8 TO PART 3 WITH 6x30 DOWELS (A) AND 5x40 SCREWS (E). THEN FASTEN PART 2 TO PARTS 6, 8, AND 7 WITH 6x30 DOWELS (A) AND 5x40 SCREWS (E).

**Paso 04** FIJE LA PARTE 8 A LA PARTE 3 CON CLAVIJAS 6x30 (A) Y TORNILLOS 5x40 (E). DESPUÉS FIJE LA PARTE 2 A LAS PARTES 6, 8 Y 7 CON CLAVIJAS 6x30 (A) Y TORNILLOS 5x40 (E).

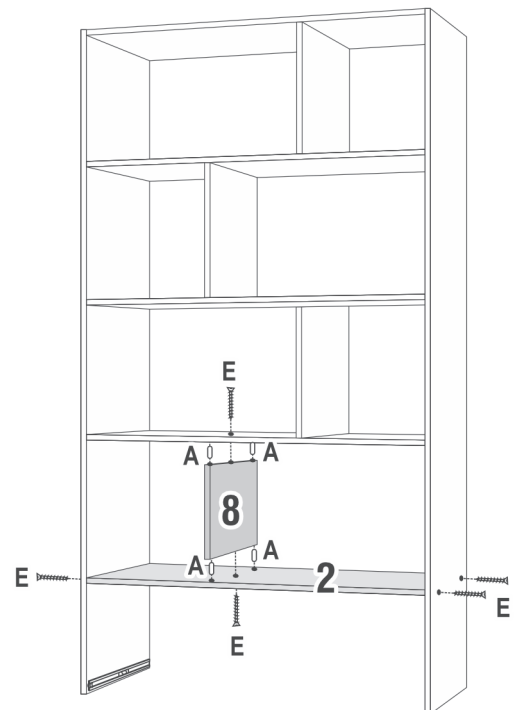

Passo 05 PARAFUSE A PEÇA 01 NAS PEÇAS 06 E 07 COM PARAFUSO 5x40 (E) E PARAFUSE OS PÉS COM PARAFUSO 4x20 (C).

Step 05 FASTEN PART 1 TO PARTS 6 AND 7 WITH 5x40 SCREWS (E). ATTACH THE FEET WITH 4x20 SCREWS (C).

Paso 05 FIJE LA PARTE 1 A LAS PARTES 6 Y 7 CON TORNILLOS 5x40 (E). FIJE LAS PATAS CON TORNILLOS 4x20 (C).

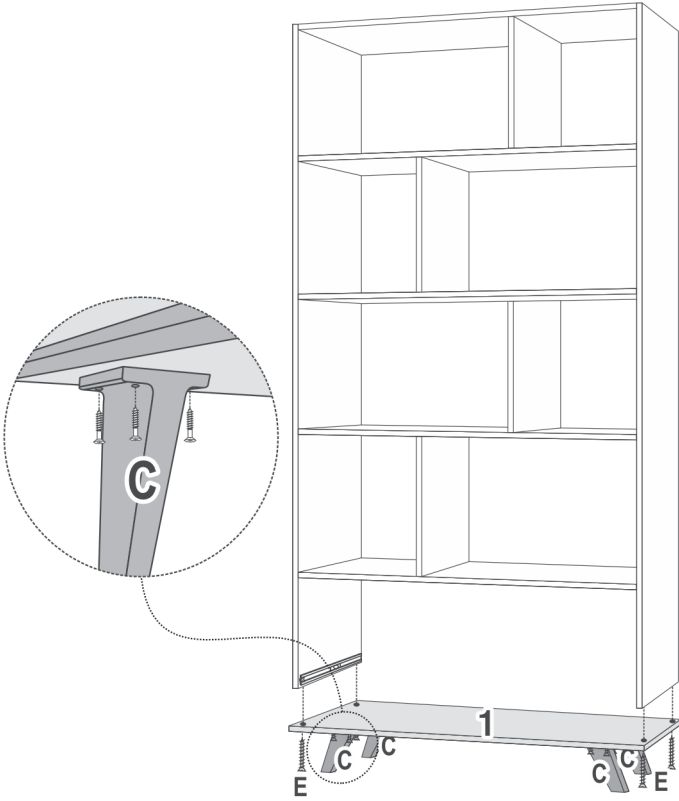

C = 16 

E = 4 

Passo 06 PREGUE A COSTAS (PEÇA 13) COM PREGO 8x8 (H) E PARAFUSE A PEÇA 14 COM PARAFUSO 3,5x14 FLANGEADO (D), CONFORME O DESENHO ABAIXO.

Step 06 FASTEN THE BACK PANEL (PART 13) WITH 8x8 NAILS (H). FASTEN PART 14 WITH 3.5x14 FLANGE SCREWS (D), ACCORDING TO THE DRAWING BELOW.

Paso 06 FIJE EL PANEL TRASERO (PART 13) CON CLAVOS 8x8 (H). FIJE LA PARTE 14 CON TORNILLOS FLANGE 3,5x14 (D), SEGÚN EL DIBUJO ABAJO.

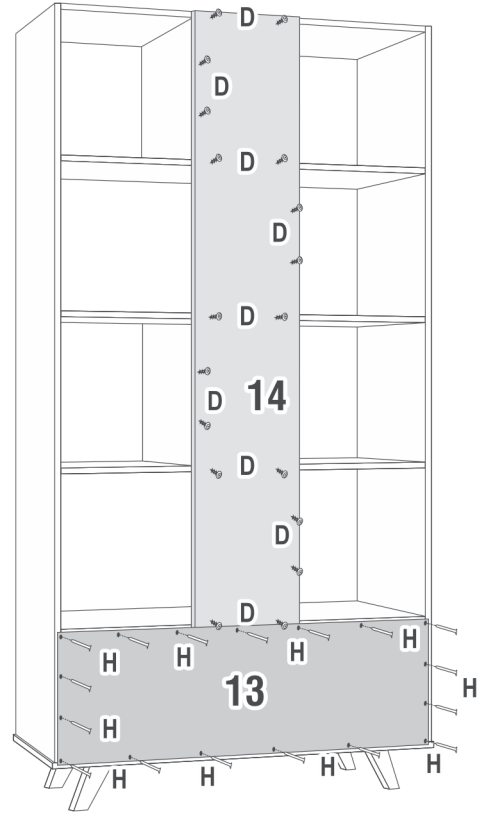

D = 18 

H = 16 

Passo 07 MONTE A GAVETA COM AS RESPECTIVAS FERRAGENS.

Step 07 ASSEMBLE THE DRAWER WITH ITS HARDWARE.

Paso 07 MONTE EL CAJÓN CON SUS HERRAJES.

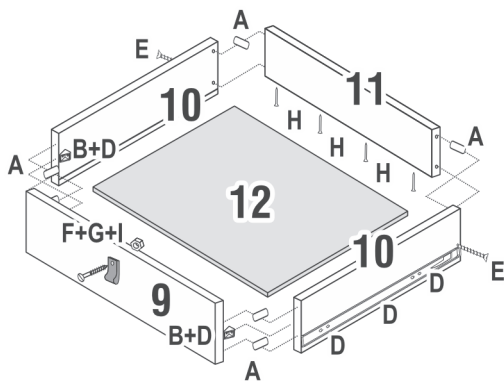

A = 6 

B = 2 

D = 10 

E = 2 

H = 4 

F = 1 

G = 1 

I = 1 

Passo 08 PRODUTO MONTADO.

Step 08 PRODUCT ASSEMBLED.

Paso 08 PRODUCTO ARMADO.

